



Eagle Expedition™

INSTALLATION AND
OPERATION INSTRUCTIONS



TM

Copyright © 1996, 1997 Eagle Electronics
All rights reserved.

Eagle Expedition™ is a trademark of Eagle Electronics
Eagle® is a registered trademark of Eagle Electronics

WARNING!

USE THIS UNIT ONLY AS AN AID TO NAVIGATION. A CAREFUL NAVIGATOR NEVER RELIES ON ONLY ONE METHOD TO OBTAIN POSITION INFORMATION.

Never use this product while operating a vehicle.

CAUTION

When showing navigation data to a position (waypoint), this unit will show the shortest, most direct path to the waypoint. It provides navigation data to the waypoint regardless of obstructions. Therefore, the prudent navigator will not only take advantage of all available navigation tools when travelling to a waypoint, but will also visually check to make certain a clear, safe path to the waypoint is always available.

The storage temperature for your unit is from -4 degrees to +167 degrees Fahrenheit (-20 to +75 degrees Celsius). Extended storage temperatures higher or lower than specified will cause the liquid crystal display to fail. Neither this type of failure nor its consequences are covered by the warranty. For more information, consult the factory customer service department.

All features and specifications subject to change without notice.

Eagle Electronics may find it necessary to change or end our policies, regulations, and special offers at any time. We reserve the right to do so without notice.

All screens in this manual are simulated.

INTRODUCTION	1
INSTALLATION	2
BATTERY INSTALLATION	2
EXTERNAL POWER	3
KEYBOARD	3
OPERATION	4
TURNING POWER ON	4
MENUS	4
FINDING YOUR POSITION	4
COLD START	4
INITIALIZATION	5
POSITION/NAVIGATION DISPLAYS	7
NAVIGATION SCREENS	7
CDI	9
PLOTTER	10
PLOTTER CURSOR	10
PLOTTER OPTIONS	11
PLOTTER ORIENTATION	11
CLEAR PLOT TRAIL	12
SAVE PLOT TRAILS	12
RECALL PLOT TRAIL	13
GRID LINES	13
PLOTTER UPDATE	14
ICONS	14
PLACE ICON - CURSOR LOCATION	15
ERASE ICONS	15
WINDOWS	16
SATELLITE INFORMATION SCREEN	17
CLOCK	17
CLOCK ALARM	18
TIMERS	18
REPROGRAM BOXES	19
WAYPOINTS	20
SAVING YOUR PRESENT POSITION (QUICK SAVE)	20
SAVING CURSOR POSITION	20
SAVING YOUR PRESENT POSITION	21
EDIT WAYPOINT LAT/LON	22
WAYPOINT NAMES	22
MOVE A WAYPOINT	23
DISTANCE BETWEEN WAYPOINTS	24
WAYPOINT OPTIONS	24
DELETE A WAYPOINT	25
ROUTES	25
CREATE A ROUTE	25
SELECT WAYPOINTS FOR ROUTE	26
FINISHING THE ROUTE	27
DELETE A WAYPOINT FROM ROUTE	27
WAYPOINT DETAIL	27
FOLLOW A ROUTE	28
DELETE A ROUTE	29
NAVIGATION	29
NAVIGATE TO A WAYPOINT	29
NAVIGATE TO A CURSOR LOCATION	29
NAVIGATING TO A WAYPOINT USING THE PLOTTER	30
CANCEL NAVIGATION	30

SYSTEM SETUP	31
BACKLIGHT	31
SOUND	31
CONTRAST	31
UNITS OF MEASURE	32
NMEA/DGPS	32
NMEA OUTPUT	34
DGPS	34
SERIAL COMMUNICATION SETUP	35
RESET OPTIONS	35
RESET GROUPS	35
SYSTEM INFO	35
GPS SETUP	36
COLD START	36
POSITION FORMAT	37
DATUM	38
PCF	39
POSITION PINNING	40
ALARMS	40
MESSAGES	41
SIMULATOR	42
STARTING POSITION	42
USER ARROW KEYS TO STEER	42
DEFINITION OF TERMS/ABBREVIATIONS	43
WINDOW GROUPS	44
LIST OF DATUMS	46
WARRANTY STATEMENT	51
UPS RETURN SERVICE	52
HOW TO OBTAIN SERVICE - INTERNATIONAL	INSIDE BACK COVER
HOW TO OBTAIN SERVICE - U.S.A. ONLY	BACK COVER

Congratulations!

You have purchased one of the finest 12-channel GPS receivers Eagle™ has ever made. With its high contrast LCD screen, easy to use menus, and outstanding performance, we think you'll be happy with your Eagle Expedition™ for many years.

GPS works from satellites that transmit information to the world at very high frequencies. One disadvantage to this frequency is that it's "line-of-sight". In other words, the signals don't bounce around like your local radio or television. If you don't have a clear view of the sky, or if you're inside a building (such as a house), the unit probably won't be able to pick up the signals from the satellites. This is common among all GPS receivers.

Like most GPS receivers, your Eagle Expedition doesn't have a compass or any other navigation aid built into it. It relies solely on the signals from the satellites to determine its position. Speed, direction of travel, and distance are all calculated from position information. Therefore, in order for it to determine the direction you're travelling, you must be moving, and the faster - the better. This is not to say the unit won't work at walking speeds - it will. But the faster you travel, the easier it is for the unit to determine your direction.

Another factor that influences the GPS' position and navigation capabilities is called selective availability or S/A. This is small errors purposefully injected into the transmitted signal from the satellites. The government does this to degrade the system's accuracy to civilian and foreign users. Even with S/A, GPS is the most accurate navigation system ever invented on such a large scale. The Government's accuracy specification is 100 meters horizontally and 150 meters vertically 95% of the time. In other words, the position shown on your Eagle Expedition could be up to 100 meters in any direction from your actual position, and the altitude could be plus or minus 150 meters from what's shown on the screen, 95% of the time. It's also important to note that in the other five percent, your position can be closer than the above, or it can be much further away.

There are two ways around the S/A problem. One is to have the government simply turn it off. In fact, there is growing pressure on them to do that. The other method is to purchase a DGPS receiver and connect it to your Eagle Expedition. A DGPS receiver (commonly called a beacon receiver), picks up correction signals broadcast from ground stations. The Eagle Expedition takes these corrections and applies them to the position and altitude screens, giving you much better accuracy.

Even with S/A on, and without a DGPS receiver, your Eagle Expedition gives you outstanding position and navigation information. Most people are amazed when they actually use a GPS receiver and see what it does.

Please sit down with the unit and this manual and familiarize yourself with them before using the Eagle Expedition in the “real world”. A simulator is built in, which lets you practice.

INSTALLATION

The Expedition will operate from four AA batteries, one DURACELL® rechargeable battery, or from 5 to 16 volts DC. An optional cigarette lighter adapter is available to plug into a car or boat’s electrical system. The Expedition automatically switches to external power when it’s plugged into the unit. If, for any reason, the external power fails, the unit will automatically switch to the batteries.

The Expedition does not require batteries when the external power is in use, however they make a good backup in case of power failure.

BATTERY INSTALLATION

For battery operation, the Expedition requires four AA batteries or the optional DURACELL® DR-121 rechargeable battery. (The DR-121 battery comes with the Eagle® BR-1B recharger. This charger lets you recharge the DR-121 battery while it’s in the unit, plus you can use the Expedition while the battery is charging.) If you use alkaline batteries, we recommend DURACELL® brand, but other brands will work. You can also use rechargeable ni-cad batteries (however, they won’t last as long as standard alkalines). Rechargeable alkaline batteries such as RayOVac® Renewals® will also work.

Do not use heavy-duty batteries or any battery type other than the ones listed above. Do not mix different types of batteries. (For example, don’t use both alkaline and ni-cad batteries at the same time.)

To install the batteries, first turn the Expedition over on its back. Now push the two tabs to the left and raise the battery cover as shown below. The bottom part of the case holds the batteries.

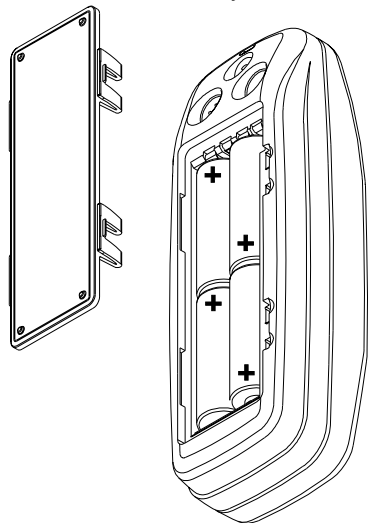

There are “+” and “-” marks on a decal at the bottom of the battery compartment. Place the batteries into the compartment according to the marks and replace the battery cover. The Expedition is now ready for use.

EXTERNAL POWER

Instead of batteries, the Expedition can operate on 5 to 16 volts DC from an external power source. To use external power, an adapter cable must be purchased (model CA-2) that will plug into your vehicle’s cigarette lighter. To use this cable, simply plug one end into the connector on the Expedition and the other end into the cigarette lighter.

KEYBOARD

The keyboard has twelve keys. The arrow keys are tied to most of the features, letting you easily move the plotter’s cursor, navigate through the menus, make selections from menus, and other tasks.

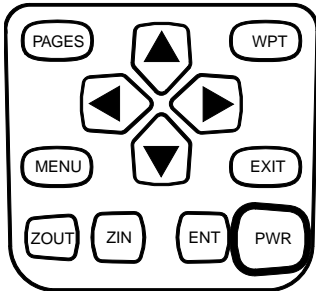

The WPT key lets you create, save, and recall waypoints and routes. The PAGES key switches the unit between the three major displays: windows, navigation, and plotter. To select different features, or to modify functions, press the MENU key. The Z-IN and Z-OUT keys zoom-in and zoom-out your view on the plotter screen. The ENT and EXIT keys let you enter or erase selections. The PWR key turns both the Eagle Expedition and it’s lights on and off.

Note: To prevent an accidental power shutdown, you must hold the PWR key down for a few seconds in order to turn the unit off.

OPERATION

Turning Power On

To turn the Eagle Expedition on, simply press the PWR key. A screen similar to the one at right appears. Read the message on the screen, then press the EXIT key to erase it. The Expedition is now ready for use.

```
DO NOT  
RELY ON  
THIS  
PRODUCT  
AS YOUR  
PRIMARY  
SOURCE OF  
NAVIGATION  
  
PRESS EXIT
```

MENUS

Most of the Eagle Expedition's adjustments and features are found on "menus". Pressing the MENU key lets you view the menus. Different menu items are added to the basic list, depending on which mode (plotter, navigation, or windows) the unit is in. This gives you the features that are specific to the mode you are in, but also has items that are used on all modes.

Pressing the up or down arrow keys moves the black box to highlight different menus on the list. Pressing the right arrow key selects the highlighted menu item.

```
SYSTEM  
SETUP  
  
ALARMS/  
CDI  
  
PLAN/EDIT  
ROUTES  
  
PLOTTER  
OPTIONS  
  
WPT/ICON  
OPTIONS
```

To erase a menu, press the EXIT key.

Finding Your Position

Cold Start

When the Eagle Expedition is turned on for the very first time, it doesn't know where it is, nor what the local time or date is. If you tell it your position, time, and date, the unit should take less time to lock-on to the satellites and give you a fix or position.

However, if you don't want to push buttons at this time, that's fine. The Eagle Expedition will lock onto the satellites and give you a position without any input from you. This is called a "cold-start". It simply means that the unit is searching without help for the satellites that are in orbit. A cold-start can take over two minutes to acquire enough satellite data to determine your position, although it typically takes less time than that.

To use your Expedition, first make certain you have a clear view of the sky, free from any obstructions such as trees or buildings. Also, don't try to use it under a carport, covered boat dock, or inside a building. Turn the power on, press the EXIT key to erase the opening message and watch the display.

As you wait for the Eagle Expedition to find your position, you'll see numbers flashing on the display. Anytime you see flashing numbers, it means the Eagle Expedition does not have a position! Do not rely on any data that is flashing! Once the Expedition locks on to the satellites and finds your position, it shows a "Position Acquired" message on the screen. It also stores the satellite data in its memory. The next time you use the unit, it should take much less time to lock on.

That's all you have to do to find your position. Your local time display may not be correct when the cold start method is used. See the initialization section for details on changing the time.

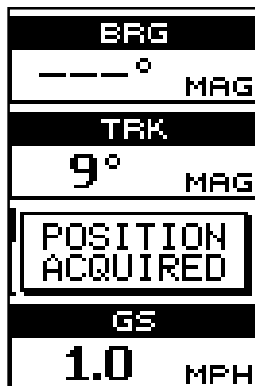

Finding Your Position

Initialization

A cold-start as described above can take over two minutes to find your position. A faster method is to initialize the Eagle Expedition manually. To do this, first press the PWR key. Next, read the message on the screen and press the EXIT key to erase it. Now press the MENU key.

Press the up or down arrow keys until the "GPS SETUP" menu is highlighted. Now press the right arrow key. Next, using the down arrow key, highlight the "INIT GPS" (initialize GPS) menu, then press the right arrow key. The screen shown at right appears.

This is the GPS initialization screen. The position, altitude, time, and date the Eagle Expedition is currently using to find the satellites is shown at the bottom of this screen. Changing these values to your local position and time will speed the position lock.

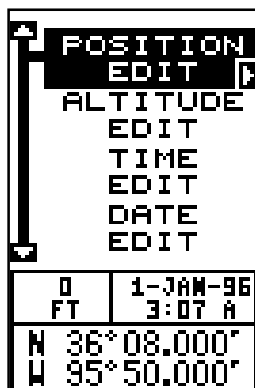

To change the position, press the right arrow key while the "POSITION" box is highlighted. The screen shown at right appears.

If your latitude is south, press the up or down arrow key to change it. If it is north, press the right arrow key to move the change box to the first number in the latitude. Now press the up arrow key to increase the number or the down arrow key to decrease it. Once the first number in the latitude is set, press the right arrow key once to move to the next number in the latitude.

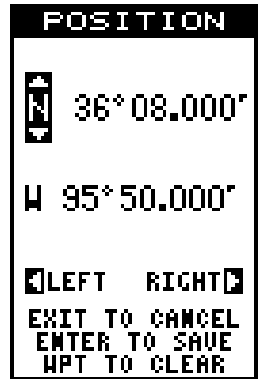

Keep pressing the arrow keys until the latitude and longitude are set to your local position. (Note: This position does not have to be very accurate. If you can get it within one degree of your actual position, that will be fine.) When it's set, press the ENT key. The Expedition accepts your entry and returns to the GPS setup menu.

Now change the local time and date (if they're incorrect) on this screen. (Don't worry about altitude.) When everything is acceptable, press the EXIT key repeatedly to return to a mode screen. The Expedition will instantly use the data you entered to find the satellites in the sky. (The unit knows which satellites will be available at the position, date, and time you entered. Therefore, it will only look for those satellites, making the search time much shorter than a cold start which looks for all of the satellites until it finds three.)

Once the Eagle Expedition finds and locks on to three satellites, it stops flashing the numbers on the display. (Note: Altitude will still flash until the unit locks on to the fourth satellite. It takes four satellites to determine altitude.)

IMPORTANT!

If the data shown in digital numbers on any screen is flashing, it means that data is invalid. **DO NOT RELY ON ANY NUMBERS THAT ARE FLASHING!** Usually, this happens when the Eagle Expedition has lost its lock on the satellites. The data that is flashing was the last known when the unit lost its navigational capability.

DO NOT NAVIGATE WITH THIS UNIT UNTIL THE DATA STOPS FLASHING!

POSITION/NAVIGATION DISPLAYS

The Eagle Expedition has navigation, plotter, and windows group modes. These screens were designed to show data that is used most often. The three default screens are shown below.

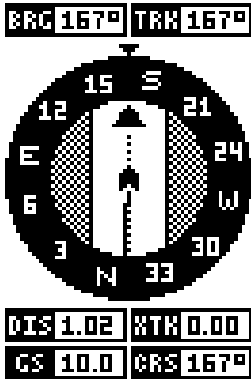

NAV-1

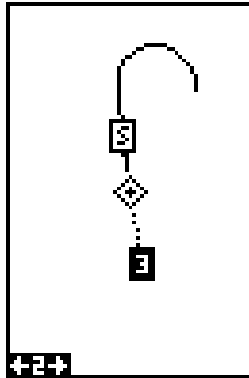

PLOT-1



GROUP A

To change screens, simply press the PAGES key. A screen similar to the one at right appears. Now press the up or down arrow keys to change modes. (The windows display is shown as "GRP" (groups).) Press the right arrow key to see more screens on each mode. When the desired screen appears, press the EXIT key to clear the menu.



Note: For a list of abbreviations used on the displays, see the back of this manual.

Navigation Screens

There are two navigation screens. Nav screen number one shows a graphical view of your trip, the other screen shows all navigation details in large digital numbers. You can customize the navigation screens to show different data than the ones chosen by Eagle. See the "Customize Screen" section for more details.

Nav Screen #1

This screen is dominated by a compass rose (See the screen at right.) Your position is in the center of the circle, designated by an arrow that always points straight up. Your track (direction of travel) is indicated by an arrow pointing down toward the compass rose at the top center of the screen. Your track in digital numbers is also shown to the right of the arrow. On the screen shown at right, the track is 167°. The line extending behind the arrow in the center shows your track history, or path you've travelled.

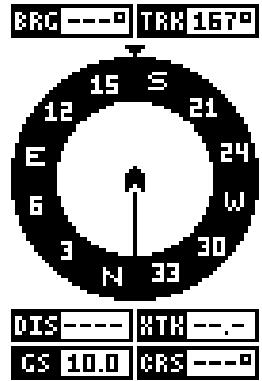

NAV-1

Your speed over ground or Ground Speed (GS) shows in the digital box in the bottom left corner of the screen. The screen looks like the one above when you're not navigating to a waypoint. (See page 28 for information on waypoint navigation.) If you navigate to a waypoint, the screen looks like the one at right.

The bearing to the destination waypoint is shown in the upper left corner of the screen. Bearing is also shown by the large arrow pointing up to the compass. The bearing is 176° on the screen at right.

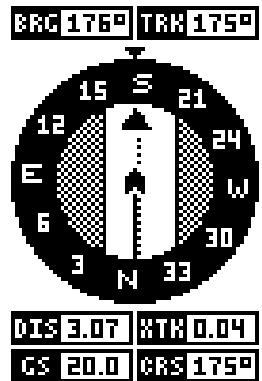

The lines on either side of the present position arrow show the cross track error range. In other words, (using the screen above as an example) if the arrow crosses the line on either side, you are .10 miles to the left or right of the desired course.

A circle depicting your destination appears on the screen as you approach the waypoint as shown on the screen at right.

The digital boxes on the bottom of the screen show your distance to go to the destination (DIS), ground speed (GS), cross track error (XTK), and course (CRS).

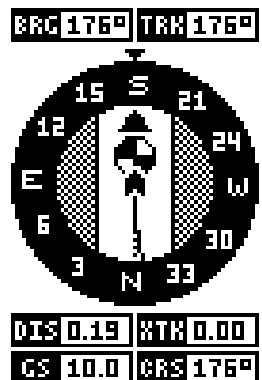

Course (CRS) is the bearing from your starting location to your destination. (Remember, course

has nothing to do with your present position, except for your starting location.) It's shown as a dotted line on the NAV 1 display. This is shown as a reminder so that if you deviate from your original course, you can easily return to it. (A "course" is a proposed path over the ground. A "track" is your actual path over ground.)

Nav Screen #2

This navigation screen shows navigation information in large digital numbers. To view this screen, press the PAGES key, then press the up arrow key until the "NAV 1" label is highlighted. Now press the right arrow key. A screen similar to the one at right appears. Press the EXIT key to erase the pages menu.

This screen is composed of eight digital display boxes, showing your track (TRK), and ground speed (GS). The other boxes show navigation data when a waypoint is recalled, including bearing to the waypoint (BRG), course (CRS), distance to waypoint (DIS), estimated time en route (ETE), and cross track error (XTK) along with a CDI. See below for more information on the CDI.



Course Deviation Indicator (CDI)

The CDI shows your distance to the left or right of the desired course. You must recall a waypoint or run a route to use the CDI. The vertical line in the center of the box shows the direction to the destination. For example, if you're travelling straight towards the destination, the line stays in the center of the CDI. If you turn to the right, the line moves to the left, showing that the destination is to your left. The CDI's range shows in the upper left corner. The default is 0.25 mile. The dots at the far right and left side of the CDI represent 0.25 mile. If the line is on either of these dots, then you are 0.25 miles off course. Remember, if the bar moves to the left, then you are too far to the *right* of the desired course line, and vice-versa. On the indicator shown above, we are almost 0.2 mile to the left of the desired course. You can adjust the CDI's range through the "ALARMS/CDI" menu.



Using the CDI with the plotter helps you visualize your position in relation to the course. The CDI is on several of the Expedition's windows.

Plotter

The plotter lets you see your course and track from a "birds-eye" view. If you've recalled a waypoint, the plotter shows your starting location, present position, and destination. However, you don't have to recall a waypoint to use the plotter.

To use the plotter, simply press the **PAGES** key, then press the up or down arrow keys until the "Plot" label is highlighted. Press the **EXIT** key to erase the pages menu. A screen similar to the one at right appears. This is plot-1. The diamond flashing in the center of the screen is your present position. The solid line extending from the diamond is your plot trail, or path you've travelled. The plotter's range is shown in the lower left corner of the screen. In this example, the plotter's range is two miles from the left edge of the screen to the right.

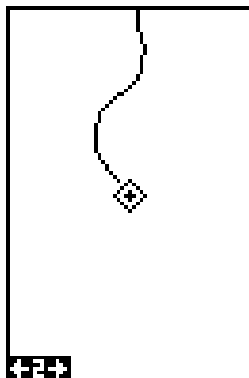

There are two different plotter screens available. Plot screen number 1 shows by default. Your current position displays at the center of the screen as a cross surrounded by a flashing diamond.

To view the other plotter screen, press the **PAGES** key. Press the up or down arrow key to move the black box to the "PLOT" label. Now press the right arrow or left arrow key to select plot-2. This screen (as shown at right) has navigation data displayed at the bottom of the screen in digital numbers. This data is active whenever you've recalled a waypoint. Press the **EXIT** key to erase the menu.

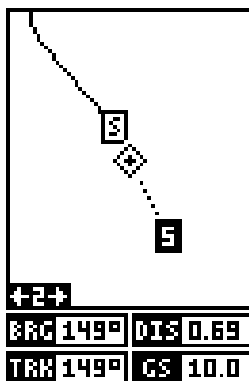

This screen shows bearing to waypoint (BRG), distance to waypoint (DIS), ground speed (GS), and track (TRK).

Use the **Z-IN** and **Z-OUT** keys to enlarge or reduce the plotter area. This changes the plotter's range. The available ranges are: 0.1, 0.15, 0.2, 0.3, 0.4, 0.6, 0.8, 1, 1.5, 2, 3, 4, 5, 6, 8, 10, 15, 20, 30, 40, 60, 80, 100, 150, 200, 300, 400, 600, 800, 1000, 1500, and 2000 miles.

Cursor

Pressing an arrow key while the plotter is on shows two dotted lines that intersect at your present position. These dotted lines are called a "cursor" and have a variety of uses.

You can move the cursor around the display by pressing the arrow keys in the direction you want it to move. This lets you view different areas of the plotter, away from your present position. When it's turned on, the zoom-in and zoom-out keys work from the cursor's position - not the present position, so you can zoom in on any detail, anywhere while navigating. The latitude/longitude of the cursor shows in the box at the top of the plot-1 screen whenever the cursor is activated. The cursor is also used to place and erase icons and waypoints.

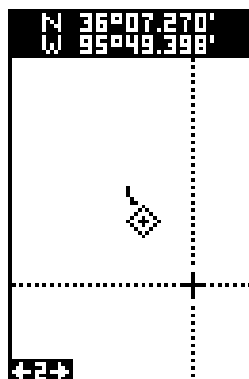

Press the EXIT key to erase the cursor.

PLOTTER OPTIONS

The Eagle Expedition lets you customize the plotter (including saving plotter trails) using the "Plotter Options" menu. To use this menu, first press the MENU key, then use the up or down arrow keys to highlight the "Plotter Options" label. Finally, press the right arrow key. The screen shown at right appears.

Plotter Orientation

Normally, the Eagle Expedition shows the plotter with north always at the top of the screen. This is the way most maps and charts are printed on paper. This is fine if you're always travelling due north. Waypoints you see to your left corresponds to the left side of the plotter, to your right shows on the right side of the plotter, and so on. However, if you travel any other direction, the plotter doesn't line up with your view of the world.

To correct this problem, the Eagle Expedition has a track-up mode that rotates the plotter as you turn. Thus, what you see on the left side of the screen should always be to your left, and so on. It also has a course-up mode that keeps the plotter at the same orientation as your initial bearing to the waypoint.

In the examples shown at the top of the next page, we're travelling south-east (about 150° magnetic). In the north-up view, the present position indicator appears to move towards the lower right corner of the screen. The anchor icon shown on the right side of the screen is actually on our left. North is always at the top center of this screen.

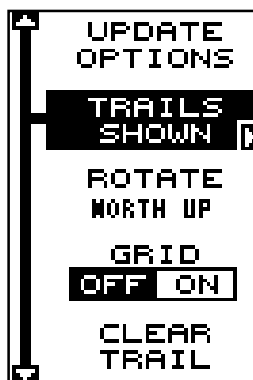

In the track-up view, the present position symbol (which has changed to an arrow) moves straight towards the top of the display. As you can see, the anchor icon is now shown in its proper orientation - to our left. A "N" shows to help you see which direction is north when the track-up mode is on. Remember, in the track-up mode, the screen rotates as you change

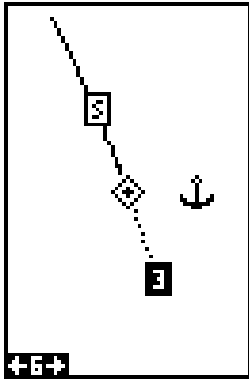

NORTH-UP MODE

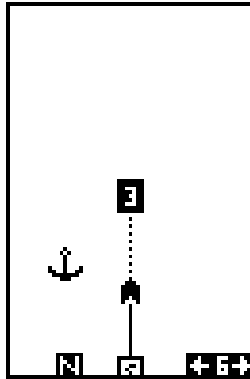

TRACK-UP MODE

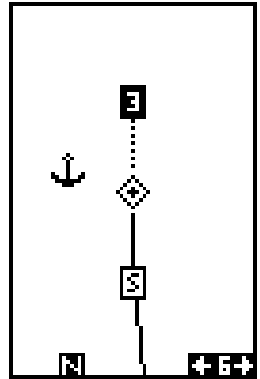

COURSE-UP MODE

direction. It always keeps your direction of travel (track) heading towards the top of the screen.

In the course-up mode, the screen is locked into your original bearing to the recalled waypoint, regardless of your track.

To select the desired mode, highlight the "ROTATE" label on the "Plotter Options" menu, then press the left or right arrow keys until the desired mode appears. Press the EXIT key to leave this menu

Clear Current Plot Trail

To erase the plot trail, highlight the "ClearTrail" label on the Plotter Options menu, then press the right arrow key. A message box appears, asking you if you really want to erase the plot trail. Follow the directions on this message box. The Expedition returns to the plotter screen with the plot trail erased from the screen.

Save Plot Trail

The Expedition automatically saves your current plot trail in memory when you turn it off. It can save two other trails for a total of three. To save your current plot trail into a memory location, press the MENU key, then highlight the "Plotter Options" menu and press the right arrow key. Now highlight the "Save Trail" menu and press the right arrow key. The screen shown at the top of the next page appears.

Use the up or down arrow key to highlight the desired trail number, then press the right arrow key to save the current trail. A message appears, asking if you really want to save this trail. Follow the directions on the screen. After you've saved the trail, press the EXIT key to erase the plot trail save menu.



Recall Plot Trail

Once you've saved a plot trail, you'll want to show it on the plotter screen. To do this, highlight the "Trails Shown" menu on the "Plotter Options" menu and press the right arrow key. A screen similar to the one shown below right appears.

The first menu item lets you turn the current plot trail off or on again. If you turn the current trail off, the plotter's present position icon will continue to move on the screen, but a trail will not be shown.

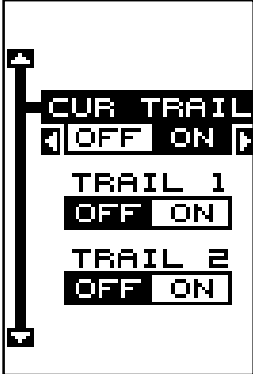

To recall a saved trail, highlight "Trail 1" or "Trail 2", then press the right arrow key. Press the EXIT key repeatedly until all menus are erased. The recalled trail will be displayed on the plotter screen. Note: You may need to scroll over to the saved trail or zoom out to see it if you are some distance away from it.

Grid Lines

The Eagle Expedition can place grid lines on the plotter to help you see your position, or the position of waypoints and icons.

To do this, highlight the "Grid" label on the "Plotter Options" menu, then press the right arrow key to turn them on. Press the EXIT key to exit this menu. A plotter screen similar to the one at right appears. The grid lines appear as vertical and horizontal dashed lines.

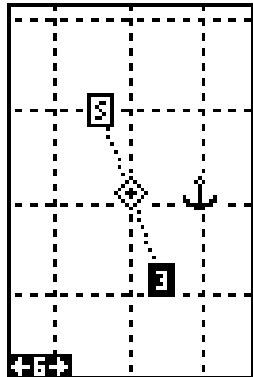

GRID LINES

Plotter Update

The plotter places a dot on your trail as you move. It determines when to place a dot depending on either time or distance. By default, it places a dot every three seconds.

To change the update method from time to distance, highlight the "Update Options" label on the "Plotter Options" menu, then press the right arrow key. The screen shown at right appears.

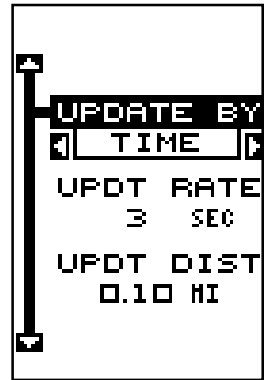

If you want to change the update time or distance, simply highlight either the "Update By" label, then press the right or left arrow key. To change the update time or distance, highlight the "UPDT RATE" (time) or the "UPDT DIST" (distance) label, then press the left or right arrow keys until the desired setting appears. Press the EXIT key to erase this menu.

ICONS

The Eagle Expedition has fifteen symbols or "icons" available. These icons can be placed anywhere on the plotter screens. These can be used to mark fishing or hunting spots, boat ramps, rest stops, or whatever. You can place an icon at your present position, or at the cursor's location.

Place Icon - Present Position

To place an icon at your present position, simply press the ENT key. The screens shown below appear. Use the arrow keys to move the black box to the desired icon. Now press the ENT key again. The plotter screen appears with the icon you selected placed at your position when you first pressed the ENT key, not your present position.

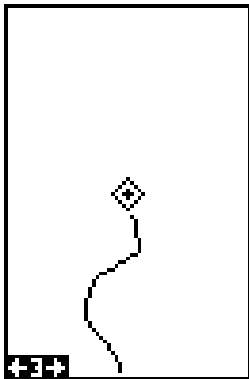

PRESS ENT KEY

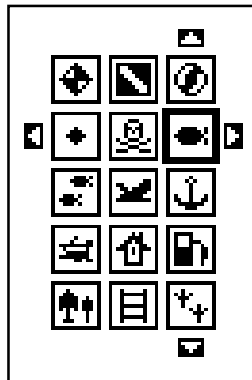

SELECT ICON

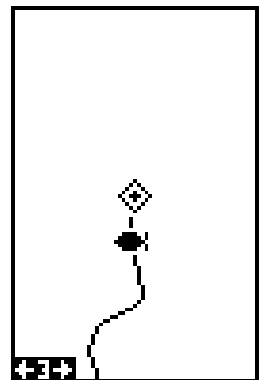

ICON ON PLOTTER

Place Icon - Cursor Location

To place an icon at cursor's location, first use the arrow keys to move the cursor to the position that you want to place the icon. Next, press the ENT key. Now select the desired icon using the arrow keys. When it's selected, press the ENT key again. The plotter screen reappears with the icon at the cursor's location. Press the EXIT key to erase the cursor. On the screens shown below, the house icon was selected and placed at the cursor location.

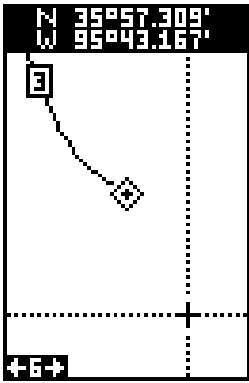

MOVE CURSOR

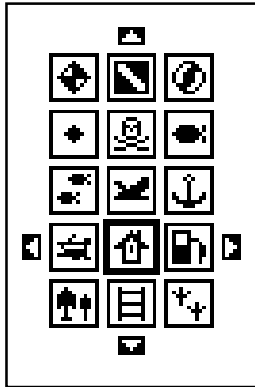

PRESS ENT KEY AND SELECT ICON

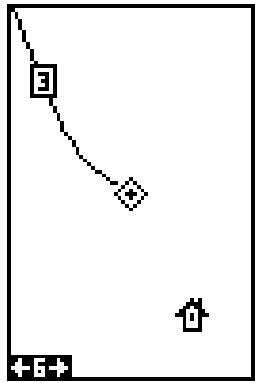

ICON ON PLOTTER

Erase Icons

To erase an icon from the screen, first press the MENU key, then select the "WPT/Icon Options" menu. A screen similar to the one at right appears.

There are three methods used to erase icons from the screen. You can delete all of the icons, regardless of their position on the display, delete all of the icons of a certain type, or selectively erase individual icons. You can also simply turn all of the icons off without erasing them.

To turn all of the icons off, without erasing them, highlight the "ICONS OFF ON" label, then press the left arrow key. To erase all of the icons, highlight the "DEL ALL ICONS" menu, then press the right arrow key. A message appears, asking you if you want to delete all icons. Press the right arrow key to erase them. The unit returns to the plotter screen with all icons deleted.

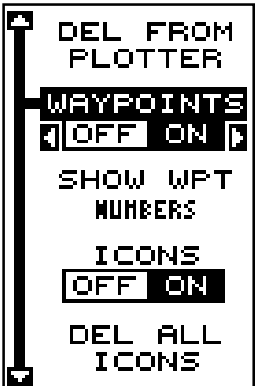

To remove only icons of a certain type, highlight the “DEL ICON TYPE” label. Press the right arrow key. The icon selection menu appears. Use the arrow keys to highlight the icon style that you wish to erase. Press the ENT key when you’re ready to erase the icons. A message appears, asking you if you want to delete the icons of that type. Press the left arrow key to erase them. The unit returns to the plotter screen with all icons of the type you selected erased.



To remove only certain icons, highlight the “DEL FROM PLOTTER” label. Press the right arrow key. The unit returns to the plotter screen with the cursor centered on your present position as shown at right. Use the arrow keys to move the cursor to the icon on the map that you wish to erase. Press the ENT key to erase the icon. If you wish to delete another icon, move the cursor over it and press the ENT key. When you’re finished, press the EXIT key to erase the cursor.

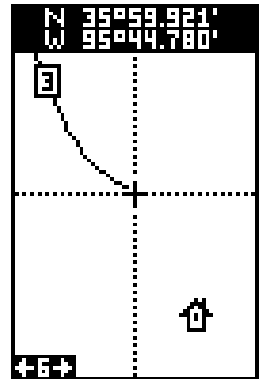

WINDOWS

This feature gives you 15 different groups of windows so you can use the best navigation display for your situation.

To use the windows feature, press the PAGES key, then highlight the “GROUP A” label as shown at right. Group “A” is visible in the background when you switch to the windows groups. To view each group, simply press the right or left arrow key while the pages menu is showing. Each group shows in the background as you press the arrow keys. When you see the group you want to use, simply press the EXIT key to erase the pages menu.

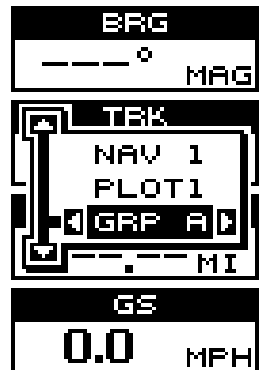

Satellite Information Screen (Group O)

This screen shows technical information about the status of the GPS receiver. The receiver has twelve channels. Data for each channel is shown as bar graphs on the right side of the display. Every satellite in the constellation has a number assigned to it, called the PRN. The bar graph is beside each satellite's number. The higher the bar on the graph, the better the signal is being received from the satellite.

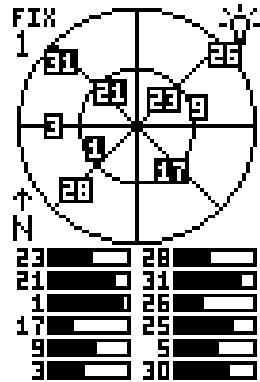

Each satellite is also shown on the circular graph at the top of the screen. This shows you not only which satellites are in your area, but also their direction from your position, and their elevation (distance above the horizon.) The small inner circle represents 45° above the horizon and the large outer circle represents the horizon. A satellite is straight above you when it is at the intersection of the horizontal and vertical lines that pass through the circles. The "N" on the left center of the screen shows the direction of north relative to the satellite graph.

The FIX number in the top left of the screen shows the quality of fix. If the FIX is 9, then it's the best you can get. A FIX of 1 is the worst. The light bulb in the top right corner of the screen shows when the backlight is on.

CLOCK

Whenever a clock, timer, or alarm is showing on a display, new items appear in the list when you press the MENU key. These items let you set the clock's time, alarms, or the timers.

Set Local Time

If the time shown on the clock display is not your local time, change it using the "Set Local Time" function. To do this, press the MENU key, then highlight the "Set Clock" label. Press the right arrow key. The screen at right appears.

Using the right and left arrow keys, move the black box to the first number in the time that you want to change. Now press the up or down arrow keys until the desired number shows. Continue until the time shown in the display is correct, then press the ENT key. This enters the new time and erases the set local time menu.

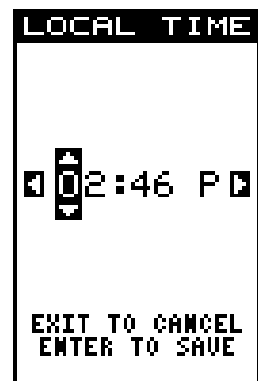

Clock Alarm

You can set the alarm by using the “Clock Alarm” menu. To set this alarm, press the MENU key while group “J” is showing, then highlight the “Clk Alm Set” label. Press the right arrow key. The screen shown below appears. Using the right and left arrow keys, move the black box to the first number in the time that you want to set. Now press the up or down arrow keys until the desired number shows. Continue until the time shown in the display is correct, then press the ENT key. The alarm is now set.



To turn the alarm on, press the MENU key, then highlight the “CLK ALM” menu. Press the right arrow key. The alarm is now activated.

When the alarm goes off, a message flashes on the screen. Press the EXIT key to turn the alarm off.

Note: The Eagle Expedition must be on in order for the alarms to work. In other words, if you set the alarm to go off at 7:00 a.m., then the Eagle Expedition will have to be on at 7:00 a.m., also.



Timers

The Eagle Expedition has two timers built in. One is a countdown timer and the other is a count-up timer. The countdown timer counts down from the time you put in to zero. The count-up timer starts at zero and counts up to the time you entered.

To set either timer, first switch to a window group with a timer. Next, press the MENU key, then highlight the desired timer set menu. In this example, we’re setting the countdown timer. Now press the right arrow key. A screen similar to the one at right appears.

Using the right and left arrow keys, move the black box to the first number in the time that you want to set. (The time is in hours, minutes, and seconds) Now press the up or down arrow keys until the desired number shows. Continue until the time

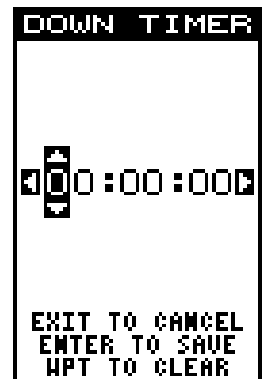

shown in the display is correct, then press the ENT key.

To start the timer, press the MENU key, then move the black box to the "Dn Tmr Off On" label. Press the right arrow key to start the timer. The timer continues counting until you stop it. If you turn the up timer's alarm on (press the right arrow key when the black box is on the (Up ALM...Off/On label), it will flash a message when it reaches the time you entered in the up timer set menu. Press the EXIT key to erase the message.

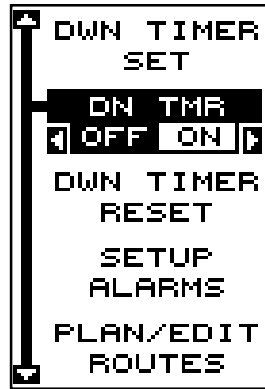

You can reset either alarm to the time you originally set by pressing the MENU key, then moving the black box to either the "Up Tmr Reset" or "DN Tmr Reset" label, then press the right arrow key.

REPROGRAM BOXES

The digital boxes on the PLOT-2 and both NAV screens can be reprogrammed. The changes you make to the screen will remain in memory, even if all power is removed from the unit. You can, however, return the boxes to the factory settings from the "Preset Groups" item in the "System Setup" menu.

To customize a screen, first switch to the screen that you want to customize. In this example, we'll change Plot-2. Next, press the MENU key, then highlight the "Reprgr Boxes" menu. Press the right arrow key. The screen shown below center appears.

This is the plot-2 edit screen. The "BRG" box near the left corner flashes, which means it's ready for change. If you don't want to change this box, simply press the up or down arrow key to move to the box that you do

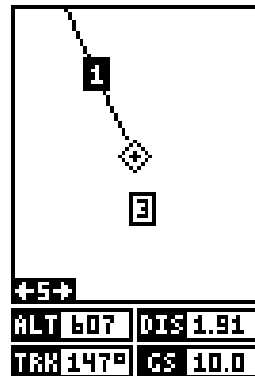
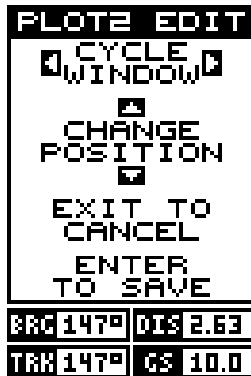
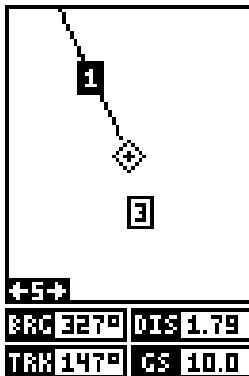

want to change. In this example, we will change the BRG box to altitude (ALT). To do this, simply press the left or right arrow key while the box is flashing. The box changes each time the arrow key is pressed. When the desired box appears, then you can change another box or save your changes by pressing the ENT key. If you want to leave this screen without saving the changes, simply press the EXIT key. In this example, we simply changed the BRG to ALT, then pressed the ENT key. The screen on the right on the previous page is the final version. Use this same method to change the NAV screens.

WAYPOINTS

The Eagle Expedition gives you the capability of creating your own database of locations, called "waypoints". You can save your present position, cursor position, or enter a latitude/longitude and save it as a waypoint. The Eagle Expedition can store up to 750 waypoints.

Saving Your Present Position as a Waypoint (Quick Save Method)

To save your present position, simply press the WPT key *twice*. The Eagle Expedition puts your current position into the first available waypoint number on the list. A message appears on the display telling you the waypoint number it just used. This also momentarily places you in the database menu. Anytime a database menu is showing, simply press the WPT key once and the unit will store your present position in the waypoint list.

Every time you save a waypoint, the date and time are logged along with the position data. It's position is also placed on the plotter as shown above. In this case, waypoint number one was assigned when we quick-saved our position.

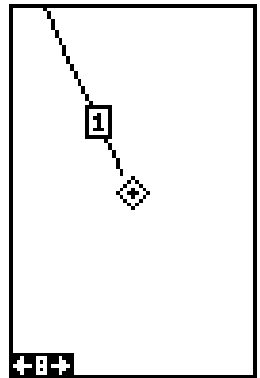

Saving The Cursor Position as a Waypoint

When the cursor is showing on the plotter and you press the WPT key twice, the Eagle Expedition puts the *cursor's* position into the first available waypoint number. In the example screen shown at right, the cursor is placed at the desired location. Pressing the WPT twice causes waypoint number two to be placed at the cursor's crosshairs. (See the screen at the top of the next page.) A message appears on the display telling you the

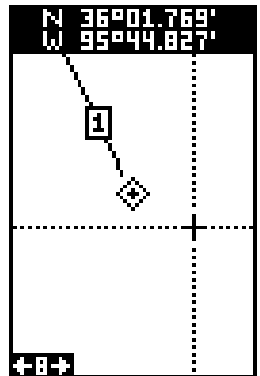

waypoint number it just used. Wait a few seconds and the menu will clear automatically. Press the EXIT key to erase the cursor.

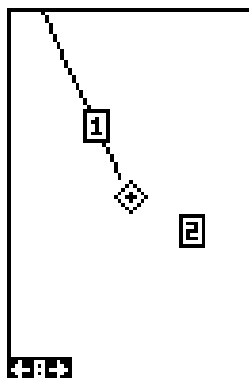

Saving Your Present Position as a Waypoint (Select Number Method)

The method shown above doesn't let you choose the waypoint number. You can pick the waypoint number, then save your present position. To do this, first press the WPT key once. A screen similar to the one at right appears.

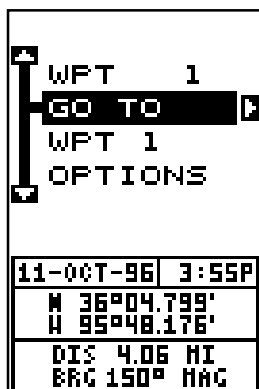

Now press the up arrow key once. This is the waypoint number selection menu. Press the left or right arrow keys until the waypoint number appears that you wish to store your present position. In this example, we're going to store a position as waypoint number 6.

Now press the down arrow key until the "WPT Options" label is highlighted. Press the right arrow key. A screen similar to the one shown at right appears.

Highlight the "SaveWPT As" label (shown at the bottom of the menu) and press the right arrow key when you're at the location you wish to save. This saves your present position under the waypoint number you selected on the first page.

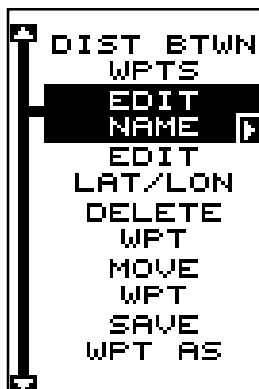

Saving Cursor Position as a Waypoint (Select Number Method)

To save the cursor position under a specific waypoint number, first position the cursor at the de-

sired position. Then follow the previous instructions for saving your present position as a waypoint using the select number method. Remember, the *method* of saving your present position and the cursor's position is identical.

Edit Lat/Lon

The Eagle Expedition lets you enter any latitude/longitude using the keyboard and save it under any waypoint number, from 1 to 750. You can also change any waypoint's position using this method. To do this, first select the waypoint number that you want to save a position under from the waypoint menu. In this example, we'll use waypoint number 10. Next, highlight the "Options" menu and press the right arrow key. Now highlight the "Edit Lat/Lon" menu and press the right arrow key. The screen shown at right appears. Using the left and right arrow keys, highlight each number in the position and change it using the up and down arrow keys. When you're ready to save this position and return to the waypoint screen, press the ENT key. The location you entered shows at the bottom of the screen under the waypoint number you selected. Note: You can also use this method to change the position of an existing waypoint.

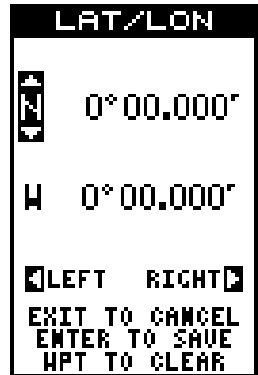

WAYPOINT NAMES

The Expedition automatically assigns the waypoint number as a name when the waypoint position is saved. You can find a waypoint by highlighting the name on the waypoint menu as shown below left. Now press the right arrow key. The screen shown below right appears. Use the arrow keys to scroll through the saved waypoints. Only waypoints that have a position will show using this method.

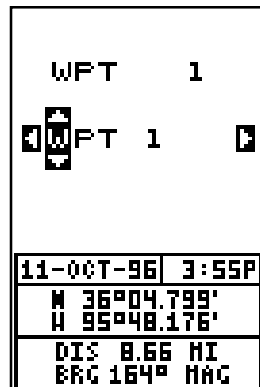
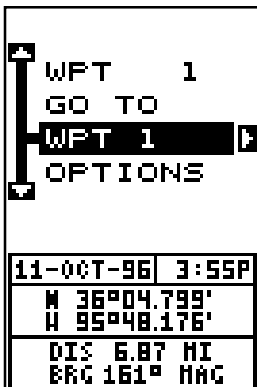

Edit Name

The Eagle Expedition also lets you assign a name to each waypoint. The name can have up to eight characters. To name a waypoint, first select the waypoint number that you wish to name. Now highlight the "WPT Options" label and press the right arrow key. Finally, highlight the "EDIT NAME" label and press the right arrow key. A screen similar to the one at right appears.

WPT 10	
O CREEK	
1-JAN-96 12:30A	
M 36°10.234'	
N 95°50.000'	
DIS 1.04 MI	
BRG 175° MAG	

Press the up or down arrow keys to select the first letter in the name. Press the right arrow key to move the black box to the next position in the name. Repeat this sequence until you've entered all of the letters in the waypoint name. Press the ENT key to accept this name, the WPT key to erase all characters in the name, or the EXIT key to leave this screen without saving any changes.

MOVE A WAYPOINT

You can move all information from one waypoint number to another. In this example, we'll move all of the information in waypoint number 10 to waypoint number 20. To do this, highlight the waypoint options label on the waypoint screen and press the right arrow key. Now highlight the "Move WPT" label. Press the right arrow key. The screen shown at right appears. The black box is resting on the "From" label. Now press the down arrow key once to highlight the "Number" label. Press the left or right arrow key until the number 10 appears. Now highlight the "TO" label, as shown below. Highlight the "Number" label, then press the right arrow key until the desired waypoint number shows in the box. When everything on this page is correct, press the ENT key.

MOVE WAYPOINT	
FROM	TO
NUMBER	1
WPT 1	
M 36°04.799'	
N 95°48.176'	
WPT 1	
M 36°04.799'	
N 95°48.176'	
ENT=MOVE	
EXIT=CANCEL	

MOVE WAYPOINT	
FROM	TO
NUMBER	1
JO CREEK	
M 36°10.234'	
N 95°50.000'	
WPT 1	
M 36°04.799'	
N 95°48.176'	
ENT=MOVE	
EXIT=CANCEL	

Note: The names in the "From" and "To" boxes are not the waypoint numbers - they are the waypoint names. When a waypoint is moved from one number to another, the new waypoint number gets the old waypoint name. For example, moving waypoint number 2 to waypoint number 5 deposits the name "WPT 2" in waypoint 5's name field.

DISTANCE BETWEEN WAYPOINTS

The Eagle Expedition can easily give you the distance between two user waypoints. To do this, first press the WPT key, highlight the "Options" menu and press the right arrow key, then highlight the "Dist Btwn WPTS" label and press the right arrow key. The screen at right appears.

The black box is resting on the "WPT B" label. Now press the down arrow key to highlight the waypoint number label. Press the left or right arrow keys until the desired waypoint appears in the "WPT B" box.

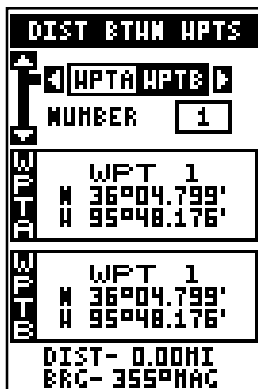

Once you have the first waypoint showing on the screen, then you need to choose the other waypoint that you're going to measure. Move the black box back to the "Select" label at the top of the screen, then press the left arrow key to select "A". Now choose the waypoint that you wish to measure. The distance and bearing from the first waypoint "A" to the second waypoint "B" shows at the bottom of the screen. You can select more waypoints to measure at this time or press the EXIT key to erase this screen.

WAYPOINT OPTIONS

You can customize the look of the waypoints on the plotter, or even turn them off. To do this, first press the MENU key, then highlight the "WPT/Icon Opts" label. Press the right arrow key. The screen shown at right appears.

To keep the waypoints from showing on the plotter, simply press the right arrow key when the "Waypoints" label is highlighted.

To change the method waypoints show on the plotter, highlight the "SHOW WPT" label. The default is numbers. In other words, when the waypoint shows on the plotter, it's number appears in a box, showing both its identity and location. You can change this from number to name, or simply an empty box (position) showing no identifiable name or number by pressing the left or right arrow keys until the desired method appears. Now press the EXIT key. This erases the menu and returns to the plotter with your selection.

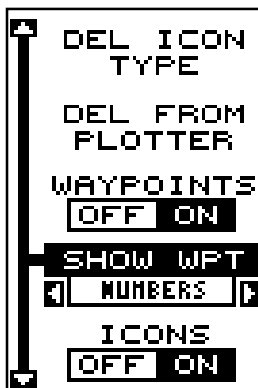

Delete a Waypoint

To erase all of the information in a waypoint, first press the WPT key, then select the waypoint you want to erase. Now highlight the "Options" label and press the right arrow key. Finally, highlight the "Delete WPT" label and press the right arrow key. A message appears, asking if you really want to delete this waypoint. Press the right arrow key to delete it, the left to exit without deleting the waypoint.

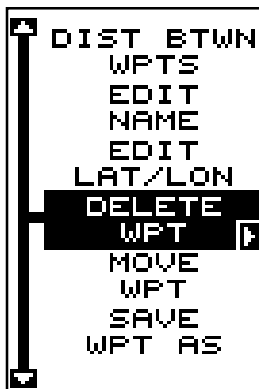

ROUTES

You can connect several user waypoints together to form a route. When you recall the route, the Eagle Expedition will show you navigation information to the first waypoint in the route, then when you reach that waypoint, it switches to the next waypoint, and so on until you reach the last waypoint in the route.

To create a route, first press the MENU key, highlight the "PLAN/EDIT ROUTES" label, and press the right arrow key. The screen shown at right appears.

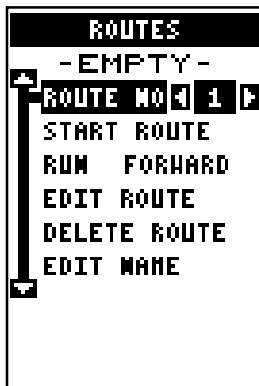

This unit can store up to fifty (50) different routes. Route number one shows on this page. If you wish to create a route using a different number, simply press the left or right arrow keys until the desired route number appears. In this example, however, we'll use route number one.

At the bottom of this menu is the "Edit Name" label. If you wish to name the route, highlight that label, then press the right arrow key. Use the arrow keys to name the route, (you can use up to eight characters in the name) then press the ENT key when you're finished.

To add waypoints to the route, highlight the "Edit Route" label and press the right arrow key. The screen shown at the top of the next page appears. This is the waypoint list screen. This shows all of the waypoints

that form the route. To select the first waypoint in the route, press the right arrow key. A new menu appears as shown below right.

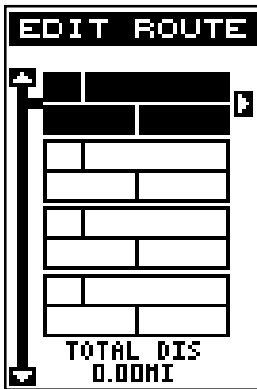

This menu lets you go to the waypoint selection menu, delete a waypoint from the route, or see details about any waypoint in the route. Since we want to add a waypoint to the route, press the right arrow key on the "Insert From WPTS" label. The screen shown below appears.

Select Waypoints

Select the first waypoint either by using the waypoint number at the top of the screen or waypoint name menus. As you move through the list of saved waypoints, their date and time saved, position, and distance and bearing from your present position show at the bottom of the screen. When the desired waypoint appears that you want to use as the first waypoint on the route, move the black box to the "Add WPT" label, then press the right arrow key. The unit returns to the route planning screen with this waypoint placed in the first location on the list.

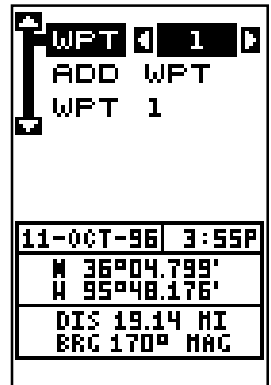

To add more waypoints to the route, simply press the down arrow key to the next position on the list and press the right arrow key. Continue until all of the waypoints have been added to the route.

As you add waypoints to the list, their bearing and distance from each other is shown to the right of the waypoint name. On the screen at right, waypoint 2 is on a bearing of 133° and 4.68 miles from waypoint 1. The total route distance is shown at the bottom of this screen.

EDIT ROUTE	
1	WPT 1
2	WPT 2
133°	4.68
3	WPT 3
321°	8.65
4	JO CREEK
355°	2.55
TOTAL DIS	
15.88MI	

Finishing the Route

When you've selected all of the waypoints for the route, simply press the EXIT key until you return to the navigation, plotter, or windows screen. Your route is saved in memory.

Delete a Waypoint

To delete a waypoint from a route, first select the route, then highlight the EDIT ROUTE label and press the right arrow key. Now highlight the waypoint that you want to remove from the route's list. Press the right arrow key. The screen shown at right appears. Highlight the "Delete" label on this menu and press the right arrow key. The unit returns to the route list with the waypoint removed from the list. (Note: This doesn't delete the waypoint from the database, it only removes it from the route.)

EDIT ROUTE							
1	WPT 1						
<table border="1"> <tr> <td>ADD WPT</td> <td></td> </tr> <tr> <td>DELETE</td> <td></td> </tr> <tr> <td>DETAIL</td> <td></td> </tr> </table>		ADD WPT		DELETE		DETAIL	
ADD WPT							
DELETE							
DETAIL							
4	JO CREEK						
355°	2.55						
TOTAL DIS							
15.88MI							

Waypoint Detail

To view the position, bearing, distance, and other information about a waypoint saved in a route, first select the route, then highlight the desired waypoint from the route's list. Now press the right arrow key. The screen shown above appears. Move the black box to the "Detail" label and press the right arrow key. The screen at right appears.

WPT	10
JO CREEK	
1-JAN-96 12:30A	
M	36°10.234'
N	95°50.000'
DIS	17.73 MI
BRC	175° MAG

This screen shows the waypoint's name, number creation time and date, icon, position, distance, and bearing from your present position. When you're finished viewing this information, press the EXIT key to erase it.

Following a Route

Before starting the route, you'll need to decide if you want to start at the beginning and travel forward or start at the last waypoint in the route and travel backwards (reverse) to the first waypoint. The default is forward. To change it, press the MENU key, then select the "PLAN/EDIT ROUTES" label and press the right arrow key. The screen shown at right appears. To run a route from the end to the beginning, highlight the "RUN" label, then press the right arrow key to change it.

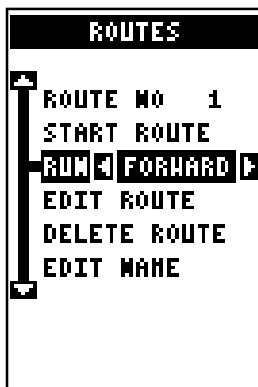

To follow a route, first select the route number that you wish to follow by highlighting the "Route No" label, and pressing the left or right arrow keys until the desired route number appears. In this example we're using route number one. Now highlight the "START ROUTE" label and press the right arrow key. The screen shown at right appears.

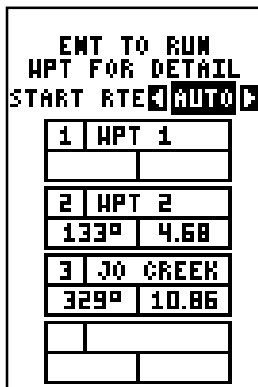

The black box is on the "Start RTE Auto" label. This starts the navigation to the waypoint that is closest to your present position. If you want to start the route with the first waypoint in the route, press the right arrow key until the number "1" appears.

If you want to see details about the highlighted waypoint, press the WPT key.

When you have everything on this screen set as desired, press the ENT key to start the Eagle Expedition navigating to the first waypoint on the route.

As you travel to the first waypoint, the unit shows navigation data to the waypoint. If you use the plotter, as shown at right, the unit draws a dotted line from your starting position (shown by the "S"), and a dashed line from the first waypoint to each of the other waypoints in the route. When you enter the radius set by the arrival alarm, the Expedition automatically switches to the next waypoint on the list, showing navigation data to that waypoint, and so on until the last waypoint on the route

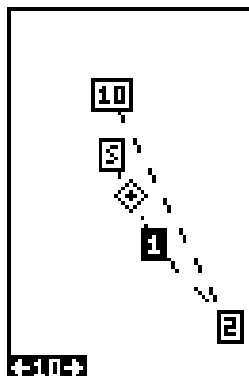

list has been reached. (Note: The arrival alarm does not have to be turned on in order to use the route feature.)

Delete a Route

To erase a route, first press the MENU key, then highlight the "Plan/Edit Routes" label and press the right arrow key. The screen shown at right appears. Now select the route you want to erase at the top of the screen, then highlight the "Delete Route" label and press the right arrow key. A message appears, asking if you really want to erase the route. If you press the right arrow key, the route will be erased.

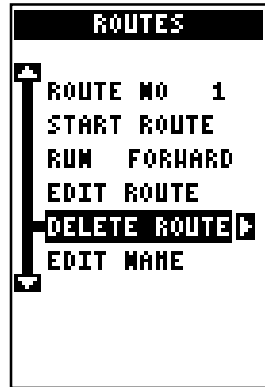

NAVIGATION

Navigate To a Waypoint

The Eagle Expedition makes it easy to navigate to any waypoint. First, press the WPT key, then select the desired waypoint by first highlighting the waypoint number at the top of the screen, then pressing the left or right arrow keys until the desired waypoint number appears. Now highlight the "Go To" label and press the right arrow key. The unit immediately returns to the navigation, plotter, or windows screen and shows navigation information to the selected location.

In this example, we recalled waypoint number 1. Switching to a plotter screen (shown at right) shows our starting location "S", the recalled waypoint "1", and our present position.

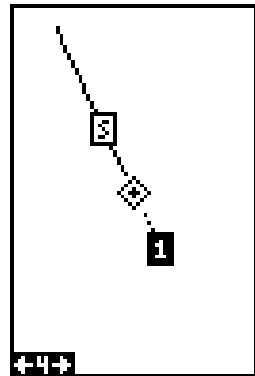

Navigating to a cursor location

The Eagle Expedition lets you navigation to a location without storing it in the waypoint database by using the plotter and cursor. To do this, first switch to the plotter screen. Now move the cursor to the location that you want to navigate to. Next, press the MENU key. A new menu appears on the list: "Go To Cursor". Press the right arrow key. The Eagle Expedition shows nav data to the cursor location (shown as "D" on the plotter). See the screens at the top of the next page.

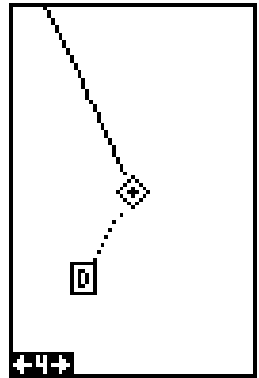
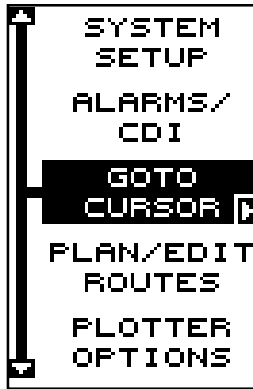
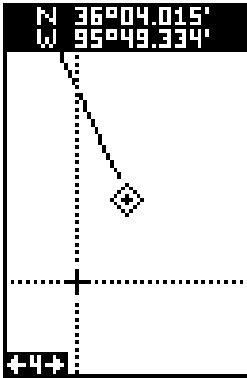

Navigating to a Waypoint using the Plotter

The unique “birds-eye” view used by the plotter gives you an easy way to navigate to a waypoint. On the plotter screen shown on the previous page, the diamond with a cross in it is your present position. The box with the “S” in it was your starting location when you recalled the waypoint. The dotted line is called a track line and is the shortest path from the starting location to the destination. The number “1” is waypoint number one, which is the recalled waypoint and the destination. The “D” on the plotter screen at the top of this page is the cursor destination, when the cursor position is used as a destination. If you follow the track line, you’ll reach the destination, covering the shortest distance in the least time.

CAUTION!

The Eagle Expedition does NOT take land features, altitudes, restricted or prohibited areas, or any other feature into account when it projects the track line on the screen. Therefore, you must use care when navigating on the track line and avoid any object that may be in your path to the destination.

CANCEL NAVIGATION

The Eagle Expedition continues to navigate to a recalled waypoint, the last waypoint in a route, or the cursor position until you stop it.

To stop the navigation function, press the MENU key, then press the up or down arrow keys until the “Cancel Navigation” label is highlighted. Press the right arrow key. The unit stops showing navigation information.

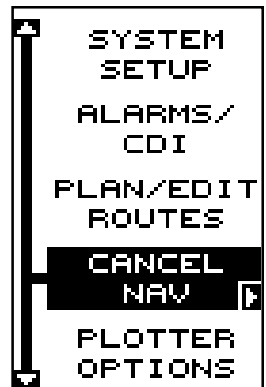

SYSTEM SETUP

The Eagle Expedition has several menus and commands listed under the “System Setup” label on the main menu. These commands affect the basic operation of the unit. To use them, press the MENU key, then highlight the “System Setup” label. Press the right arrow key. The screen shown at right appears.

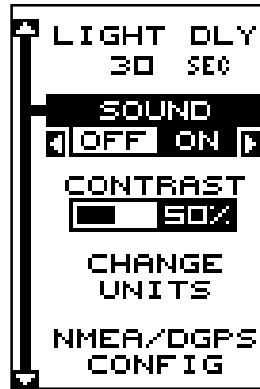

BACKLIGHT

The Expedition’s display has lights that can be turned on for night use. To turn the lights on, simply press the PWR key. To turn them off, press the PWR key again. An indicator on the satellite status screen (Group “O”) shows when the lights are on.

The Expedition automatically turns the lights off after 30 seconds to preserve the battery power. It will do this even if the external power is applied to the unit.

The time delay is adjustable from 5 to 240 seconds. You can also turn the lights on continuously from this menu. Use the “Light Dly” (light delay) menu to change this. Highlight this menu, then press the right arrow key to increase the time the lights are on, the left arrow key to decrease it. Press the EXIT key to erase this menu.

SOUND

To turn the speaker off, highlight the “SOUND” label as shown at right, then press the left arrow key. Note: This turns the speaker completely off. The unit will not sound a tone when a key is pressed, nor will any alarm sound. The alarm messages will still flash on the screen, however.

CONTRAST

To adjust the display’s contrast, highlight the “Contrast” label on the “System Setup” menu as shown above. Press the right or left arrow keys until the screen’s contrast is best for the lighting conditions. Press the EXIT key to erase this screen.

Units of Measure

The Expedition can show its data in many different formats. For example, distance can be displayed in statute miles (MI), nautical miles (NM), or kilometers (KM). The following can be changed on the “Change Units” menu: (Defaults shown in **bold**)

Clock **12-hour (a.m.-p.m.)**, 24 hour
Distance **miles**, nautical miles, kilometers
Speed **miles per hour**, knots,
kilometers per hour
Bearing **magnetic**, true
Altitude **feet**, meters



To change a unit of measure, first select the “Change Units” label from the “System Setup” menu. The screen shown above appears. Highlight the desired selection, then press the left or right arrow key. You can change any or all of the settings on this page. When you’re finished, press the EXIT key.

NMEA / DGPS

The Eagle Expedition transmits data through the data port in the back of the unit using NMEA 0183 format, version 1.5 or 2.0. This data is used by other electronic devices such as marine autopilots for position and steering information.

DGPS on the other hand, is a data input. DGPS is an acronym for Differential Global Positioning System. Currently, it relies on a system of ground-based transmitters that send correction signals to small DGPS receivers. DGPS gives you more accurate positions than is otherwise possible.

All wiring connections to the Expedition are made to it’s power cable. See the sample wiring diagrams on the next page for general wiring procedures. Read your other product’s owner’s manual for more wiring information.

Once the cables are wired, turn the Expedition on, press the menu key, and select NMEA / DGPS from the System Setup menu. A screen similar to the one at right appears.

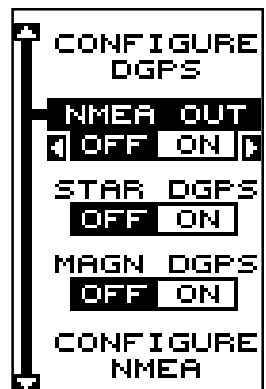

TO EXPEDITION

EXPEDITION TRANSMITTING NMEA DATA TO ANOTHER DEVICE

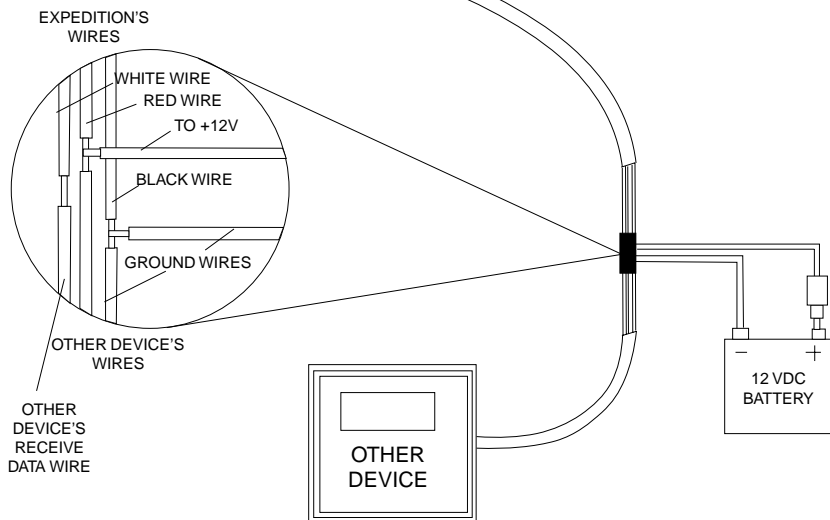

TO EXPEDITION

EXPEDITION RECEIVING DATA FROM A DGPS RECEIVER

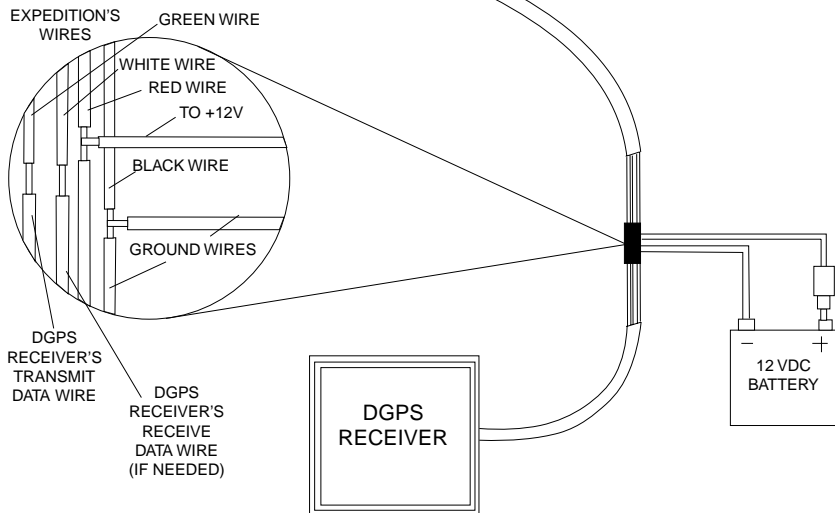

NMEA OUTPUT

To turn the NMEA output on, highlight the “NMEA OUTPUT” menu (shown at the bottom of the previous page), then press the right arrow key. If your other equipment works, then no setup will need to be performed. If your other equipment doesn’t recognize the NMEA data being sent by the Eagle Expedition and the wiring is correct, then you may need to change the NMEA or the serial communication settings.

Configure NMEA Output

Highlight the “Configure NMEA Output” menu, then press the right arrow key. A screen similar to the one at right appears.

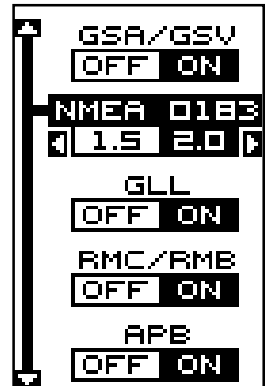

NMEA 0183 Version

There are two versions of the NMEA data, 1.5 and 2.0. If your other equipment requires 2.0, press the right arrow key to select it.

GLL, RMC/RMB, APB, GGA, GSA/GSV Sentences

Some equipment requires different sentence. The Eagle Expedition’s default setting for these sentences is on. In other words, it automatically sends these sentences when NMEA is turned on. To turn any of these off, move the black box to the desired menu and press the left arrow key. Press the EXIT key when everything on this screen is the way you want it.

DGPS

The Eagle Expedition will recognize Starlink® and Magnavox® automatic DGPS receivers. If you have either one of these receivers, simply highlight the “Star DGPS” or “Magn DGPS” on the NMEA / DGPS menu and press the right arrow key to turn it on. (Note: If you have a Magnavox DGPS receiver connected, the Eagle Expedition can’t send NMEA data.) With the exception of serial communications, typically no other setup needs to be made with these receivers.

If you have any other Magnavox or Starlink compatible DGPS receiver connected to the Eagle Expedition, you may need to change the settings. To do this, move the black box to the “Configure DGPS” label and press the right arrow key. A screen similar to the one at right appears.

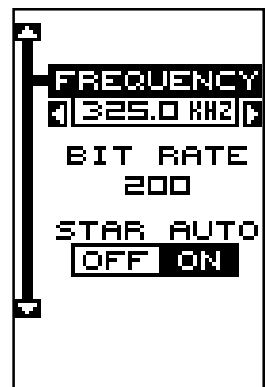

These menus select the beacon receiver's frequency and bit rate (in bits per second). To change one of these settings, simply highlight the menu item you wish to change, then press the right or left arrow key until the desired number appears. Press the EXIT key when you're finished.

SERIAL COMMUNICATIONS SETUP

To set the data port, move the black box to the "Com Port Setup" on the System Setup menu. Press the right arrow key. The screen shown at right appears.

Check your DGPS receiver's manual for the proper data settings. Highlight the menu item you need to change. Press the left or right arrow keys to change them. The serial port defaults are 4800 baud, no parity, and 8 data bits. Press the EXIT key to erase this menu.

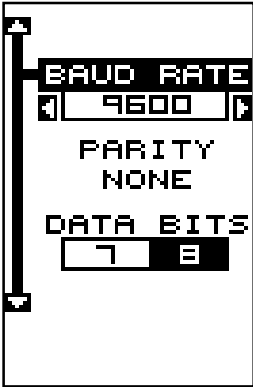

RESET OPTIONS

To return the Eagle Expedition to its original factory settings, highlight the "Preset Options" menu on the System Setup screen. Now press the right arrow key. A message appears, asking if you want to restore the original options. Press the right arrow key if you do, the left arrow key to quit.

If you restore the unit to the factory settings, all options such as contrast, alarms, and other system choices are returned to their default values. However, no waypoints, routes, or icons are erased.

RESET GROUPS

To return all groups on the navigation and plot-2 screens to their factory defaults, highlight the "RESET GROUPS" label on the "System Setup" menu. Finally, press the right arrow key. All digital boxes on these screens are reset to their factory settings.

SYSTEM INFO

The system information screen shows the release date and the version number of the code stored inside the Eagle Expedition. To view this screen, highlight the "System Info" label on the "System Setup" menu. Now press the right arrow key. A screen similar to the one at right appears. Press the EXIT key when you're finished reading this screen.



GPS SETUP

The GPS Setup menu has sub-menus that affect the GPS receiver. From these menus you can set the update rate, initialize the GPS receiver, do a self-test on the receiver, and do a cold-start. (Note: The “Initialize GPS receiver” is covered in the “Finding Your Position” section in the front of this manual.

To view these menu items, press the MENU key, then highlight the “GPS Setup” menu. Press the right arrow key. The screen at right appears.

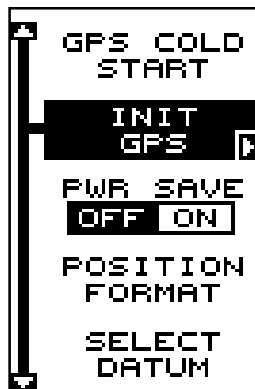

GPS Cold Start

When the Eagle Expedition is turned on for the first time “out of the box”, it automatically sends a “cold-start” message to the GPS receiver. You can also send a cold start message to the receiver at any time.

If the unit can’t lock on to the satellites using the data you’ve given it, or if it has trouble finding the satellites, perhaps it is using the wrong data. This can happen if you’ve entered the wrong data by accident when initializing the receiver. For example, if you entered east longitude instead of west. Or if you’ve moved a long distance with the unit turned off.

To send a cold start message to the receiver, highlight the “GPS Cold Start” label, then press the right arrow key. A message appears, asking you if you really want to do a cold start. Follow the instructions on this message page.

The unit will begin searching for the satellites. It can take as long as 5 minutes for it to lock on to the necessary satellites. Remember, when it does, your local time and possibly date can be wrong. Use the method shown in the initialization section at the front of this manual to change them, if needed. Once this is done, an internal clock will keep the correct time, even when the unit is turned off. The GPS system updates this clock when the unit is locked on to the satellites.

Position Format

The Eagle Expedition can show the position in degrees, minutes, and thousandths of a minute (36° 28.700') or degrees, minutes, seconds, and tenths of a second (36° 28' 40.9"). It can also show position in UTM (Universal Transverse Mercator) projection, British, Irish, Swedish, Swiss, Finnish, and Military Grid systems.

To change the position format, highlight the "Position Format" label on the "GPS Setup" menu (shown on the previous page), then press the right arrow key. A screen similar to the one at right appears.

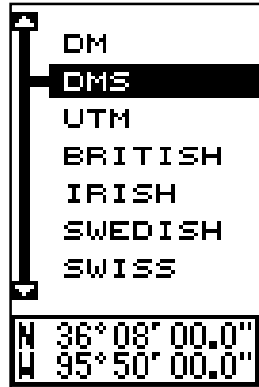

UTM's are marked on USGS topographic charts. This system divides the Earth into 60 zones, each 6 degrees wide in longitude. Their unit of measure is in meters. For example, 15N means that the position shown to the right of the "15N" is in zone 15, and it's north of the equator.

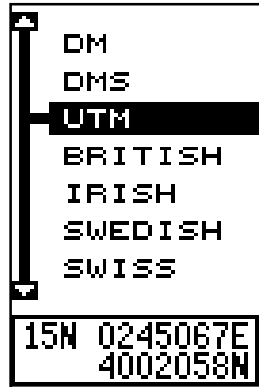

British, Irish, Swedish, Swiss, and Finnish grid systems are the national coordinate system used only in their respective countries.

Note: In order to use either the British, Irish, Swedish, Swiss, or Finnish grid systems, you must be in the respective country.

The Expedition will pick the matching datum for you when you select the grid. See the Datums section for more information.

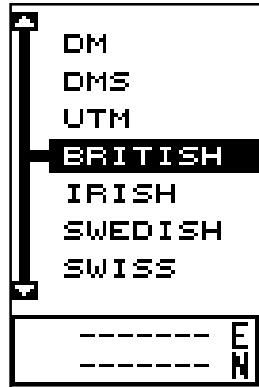

The Expedition can use the military grid reference system (MGRS). It uses two grid lettering schemes, which are referred to as standard and alternate MGRS on the Expedition. Your position and datum in use determines which one to use. If you use the standard, and your position is off significantly, then try using the alternate.

Press the up or down arrow keys to highlight the desired position format. Press the EXIT key to both select the format and erase the position format menu.



DATUM

Maps and charts are based on a survey of the area that's covered by the map or chart. These surveys are called "Datums". Maps that are created using different datums will show the same latitude/longitude in slightly different locations.

All datums are named. The GPS system is based on the WGS-84 datum, which covers the entire world. Other datums may also cover the entire world, or just a small portion. By default, the Eagle Expedition shows your position on the map using the WGS-84 datum. However, it can show your position using one of 191 different datums.

To change the datum, first press the MENU key, then highlight the "GPS Setup" label and press the right arrow key. Now highlight the "Select Datum" label. Finally, press the right arrow key again. A screen similar to the one at right appears.

The WGS-84 label is highlighted. To change it, simply press the up or down arrow keys to highlight the desired datum, then press the ENT key. This selects the datum and erases the select datum menu. To erase the menu without changing the datum, simply press the EXIT key.



A list of the datums used by the Expedition is in the back of this manual.

PCF (Position Correction Factor)

Another method used to make your display match a chart or map is called "PCF" or Position Correction Factor. This unit gives you the capability to move or offset the position shown on the display to match one on the chart. The unit will add this offset to all position and navigation displays at all times.

Remember, the position error on any radio navigation system is very dynamic and the PCF offset should never be used in an attempt to cancel the error.

In general terms, PCF should only be used if your map indicates what the possible error is. **PCF should always be reset to zero when you're finished with the chart.**

For example, suppose you are stopped at a location that is accurately marked on a chart. Your unit shows a longitude position that is .244 minutes east of the one on the chart and .047 minutes north latitude. Using the PCF feature, you can make the Eagle Expedition match the chart you're using. If you move, the unit will continuously add the change to all position, navigation, and mapping displays. This makes it more closely match the datum used by the chart. For this reason, you should be careful when entering the PCF offset. It's saved in memory and doesn't change when the unit is turned off. However, resetting the unit does erase the PCF offset.

To change the PCF offset, first press the MENU key, then highlight the "GPS Setup" label and press the right arrow key. Now highlight the "Set PCF Offset" label. Finally, press the right arrow key again. A screen similar to the one above right appears.

Now enter the correction for your location. Remember, this is the difference between the location shown on the present position display and the position shown on the chart. In this example, we entered 0 degrees, 0.047 minutes north latitude and 0 degrees, 0.244 minutes east longitude. That is the difference between the present position shown by the Eagle Expedition and the one on our chart.



After you've entered the latitude/longitude correction, press the ENT key to accept it. The Eagle Expedition erases the PCF entry screen and returns to the navigation or mapping screens with the correction factor applied.

POSITION PINNING

When using a GPS receiver at extremely low speeds, it can have trouble determining your course over ground, or direction you're travelling. This is due in large part to SA, or selective availability. SA is small inaccuracies purposefully put into the GPS satellite's signal by the government. This cause wide variations in the track display and other navigation displays when using the unit at slow speeds.

If you're using the Eagle Expedition without DGPS and stop, the position pinning feature locks the present position indicator on the plotter until you've moved a short distance or exceed a very slow speed. This prevents the "wandering" plot trail seen when you're stopped with position pinning turned off. This also affects the navigational displays.

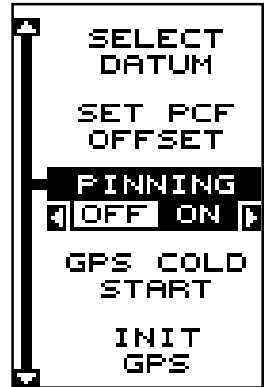

The easiest way to see the effects of S/A is to stand still with the Expedition turned on and watch your plot trail with position pinning turned off. You'll see the present position change, speed increase and decrease, and a random plot trail on the plotter's screen.

If you wish to turn the position pinning feature off, press the MENU key, then highlight the "GPS Setup" label and press the right arrow key. Now highlight the "Pinning" label. Finally, press the left arrow key.

ALARMS

The Eagle Expedition has several alarms. You can set an arrival alarm to flash a warning message when you cross a preset distance from a waypoint. For example, if you have the arrival alarm set to .1 mile, then the alarm will flash a message when you come within .1 mile of the recalled waypoint. The course deviation indicator alarm (CDI) can warn when your track drifts too far to the right or left of the line to the waypoint. For example, if the alarm is set to .1 mile, then the alarm flashes a message if you drift .1 of a mile or more to the right or left of the line to the waypoint. The anchor alarm is triggered when you drift outside of a preset radius. Again, using the .1 mile as an example, if you're anchored and your boat moves more than .1 of a mile, the alarm will flash a message.

To use any of these alarms, first press the MENU key, then select the "ALARMS/CDI" menu. A screen similar to the one shown at right appears. Press the up or down arrow key to move the black box to the desired alarm, then press the right arrow key to turn it on.

To adjust an alarm's distance, move the black box to the alarm's "DIST" menu item, then press the right or left arrow keys to increase or decrease the alarm's distance.

When you're finished adjusting the alarms, press the EXIT key to erase this menu.

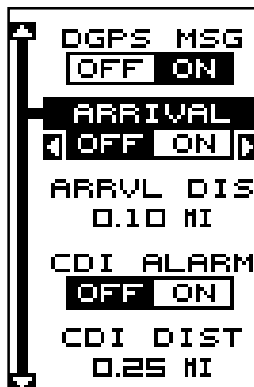

Important Alarm Notes:

Anchor Alarm - Since civilian users don't receive the accuracy given to military users, the anchor alarm may be triggered even when you're sitting still. This typically happens when using small (less than .05 mile) anchor alarm ranges. If you have a DGPS beacon receiver connected to the Eagle Expedition, smaller ranges may be usable.

Arrival Alarm - If you set the arrival alarm's distance to a small number, and you run a route (see the routes section), the Eagle Expedition may not show navigation data to the next waypoint, once you arrive at the first one, since you may not be able to come close enough to the first waypoint to trip the arrival alarm.

MESSAGES

The position and DGPS message selections are found on the Alarms/CDI menu. When turned on, the position message appears for a few seconds whenever the Eagle Expedition locks onto the satellites and shows a position. It also appears when the unit loses the lock onto the satellites and cannot navigate. Pressing the EXIT key erases these messages.

The DGPS message appears whenever the unit begins or stops using DGPS data to help determine your position.

The default setting for these messages is "on". To turn either message off, select the "Setup Alarms" menu from the main menu, then move the black box to the desired message and press the left arrow key. Press the EXIT key to erase this screen.

SIMULATOR

A simulator is built into the Eagle Expedition that has several options. You can use nearly all of the unit's features - even save and recall waypoints. This is useful for trip planning.

To use the simulator, press the MENU key, then press the up or down arrow keys until the "Simulator Setup" menu is surrounded by the black box. Now press the right arrow key. The screen shown at right appears.

If you simply press the right arrow key, turning the simulator on, the Eagle Expedition will start from your present position and follow a track of 355° at 100 miles per hour.

To change either the track or speed, highlight the one you want to change, then press the right or left arrow key. When the numbers are correct, press the EXIT key.

Starting Position

Normally, the starting position for the simulator is your present position. If you want to change the starting position, highlight the "Set Starting Waypoint" label on the Simulator Setup menu, then press the right arrow key. The screen shown at right appears.

You can select any waypoint as the simulator's starting point. Select the starting point by pressing the right arrow key on the "WPT#" label until the desired starting waypoint number appears. Now highlight the "Start At" label and press the right arrow key. The Eagle Expedition returns to the Simulator Setup menu using the waypoint you specified as the starting waypoint.

Use Arrow Keys to Steer

This option lets you change both the course and speed on the screen as the simulator is running. To do this, highlight the "Steer With Arrows" label on the Simulator Setup screen, then press the right arrow key. The screen shown at right appears. Use the up and down arrow keys to increase or de-

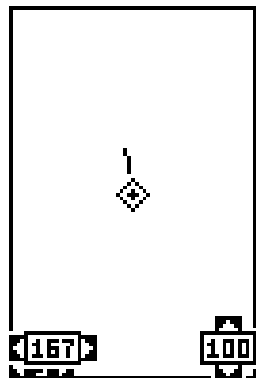
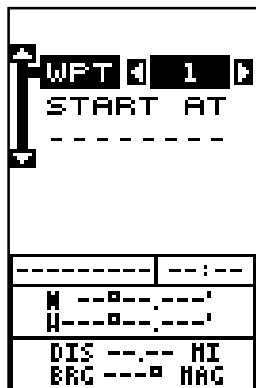
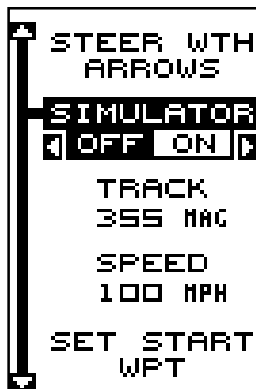

crease the speed. Use the right and left arrow keys to change the track. Press the EXIT key to erase these menus.

When you're finished changing the track and speed, press the EXIT key to erase the menus.

To turn the simulator off, press the MENU key, then move the black box to the "Simulator Setup" label. Finally, press the left arrow key.

Note: Your plot trail will be erased when you turn the simulator on or off.

DEFINITION OF TERMS/ABBREVIATIONS

Due to space considerations, the digital displays use abbreviations for some names. They are as follows:

- ALT Altitude - Your height above sea level.
- BRG Bearing - The direction from your present position to a waypoint.
- CLOCK Your local time.
- TRK Track - The direction you're travelling.
- DIS Distance - Distance remaining between your present position and a waypoint.
- DNT/UPT Countdown timer (DNT) and Count up timer (UPT)
- ETE Estimated Time En route
- FIX A measure of your receiver's position quality. A fix of 1 is bad, 9 is the best.
- ICON A symbol you can place on the map, representing a landmark.
- POSITION Your present position.
- GS Ground Speed - Your actual speed.
- TTG Time To Go - Time remaining at your present speed until you reach a waypoint.
- VOLTS Electrical system voltage.
- VMG Velocity Made Good - Your ground speed towards a recalled waypoint, airport, etc.
- XTK Cross Track Error - Shows your distance to the **side** of the desired course line.

WINDOWS

The following is a listing of windows groups A through O.

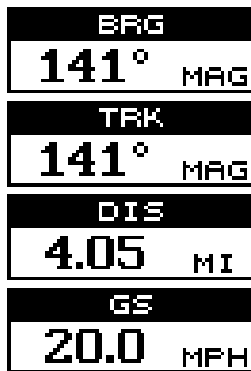

GROUP "A"



GROUP "B"



GROUP "C"



GROUP "D"



GROUP "E"

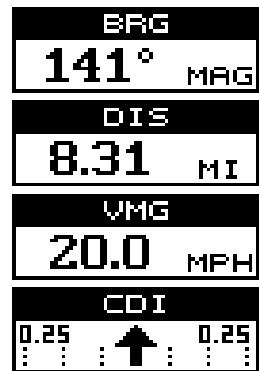

GROUP "F"

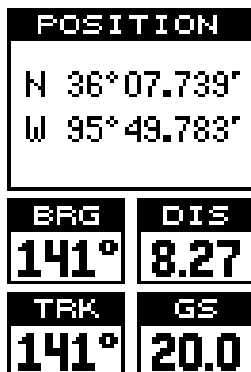

GROUP "G"

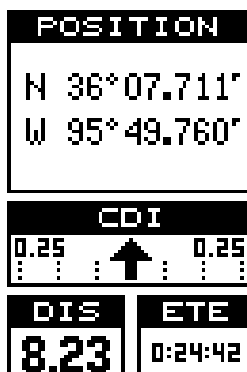

GROUP "H"



GROUP "I"



GROUP "J"



GROUP "K"

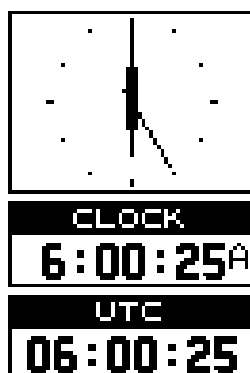

GROUP "L"

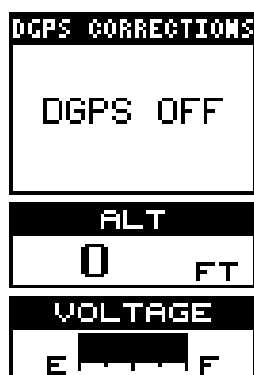

GROUP "M"



GROUP "N"

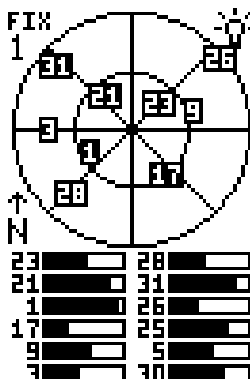

GROUP "O"

DATUMS

WGS 84	WGS 1984	ARC 1960	Arc 1960 - Mean for Kenya,
DEFAULT	Default	MEAN	Tanzania
ADINDAN	Adindan	ASCENSION	Ascension Island 1958 -
MEAN	Mean for Ethiopia, Sudan	ISLAND	Ascension Island
ADINDAN	Adindan	ASTRO BEACON ..	Astro Beacon E 1945 - Iwo Jima
BURKINA	Burkina Faso	E 1945	
FASO		IWO JIMA	
ADINDAN	Adindan	ASTRO DOS 714 ..	Astro DOS 71/4 - St Helena Island
CAMEROON	Cameroon	ST HELENA	
ADINDAN	Adindan	ISLAND	
ETHIOPIA	Ethiopia	ASTRO TERN	Astro Tern Island (FRIG) 1961 -
ADINDAN	Adindan	ISLAND	Tern Island
MALI	Mali	1961	
ADINDAN	Adindan	ASTRONOMICAL ..	Astronomical Station 1952 -
SENEGAL	Senegal	STATION '52	Marcus Island
ADINDAN	Adindan	MARCUS ISLE	
SUDAN	Sudan	AUSTRALIAN	Australian Geodetic 1966 -
AFGOOYE	Afgooye	GEODETC	Australia & Tasmania
SOMALIA	Somalia	1966	
AIN EL ABD	Ain el Abd 1970	AUSTRALIAN	Australian Geodetic 1984 -
1970	Bahrain	GEODETC	Australia & Tasmania
BAHRAIN		1984	
AIN EL ABD	Ain el Abd 1970	AYABELLE	Ayabelle Lighthouse - Djibouti
1970 SAUDI	Saudi Arabia	LIGHTHOUSE	
ARABIA		DJIBOUTI	
ANNA 1 ASTRO	Anna 1 Astro 1965	BELLEVUE	Bellevue (IGN) - Efate &
1965 COCOS	Cocos Islands	(IGN) EFATE	Erromango Islands
ISLANDS		ERRAOMANGO	
ANTIGUA	Antigua Island Astro 1943	BERMUDA	Bermuda 1957 - Bermuda
ISLAND	Antigua (Leeward Islands)	1957	
ASTRO 1943		BISSAU	Bissau - Guinea-Bissau
ARC 1950	Arc 1950	GUINEA	
MEAN	Mean for Botswana, Lesotho,	BOGOTA	Bogota Observatory - Colombia
	Malawi, Swaziland, Zaire, Zambia,	OBSERVATORY	
	Zimbabwe	COLOMBIA	
ARC 1950	Arc 1950 - Botswana	BUKIT RIMPAH	Bukit Rimpah - Indonesia (Bangka
BOTSWANA		INDONESIA	& Belitung Islands)
ARC 1950	Arc 1950 - Burundi	CAMP AREA	Camp Area Astro - Antarctica
BURUNDI		ASTRO	(McMurdo Camp Area)
ARC 1950	Arc 1950 - Lesotho	ANTARCTICA	
LESOTHO		CAMPO	Campo Inchauspe - Argentina
ARC 1950	Arc 1950 - Malawi	INCHAUSPE	
MALAWI		ARGENTINA	
ARC 1950	Arc 1950 - Swaziland	CANTON ASTRO ..	Canton Astro 1966 - Phoenix
SWAZILAND		'66 PHOENIX	Islands
ARC 1950	Arc 1950 - Zaire	ISLANDS	
ZAIRE		CAPE	Cape - South Africa
ARC 1950	Arc 1950 - Zambia	SOUTH	
ZAMBIA		AFRICA	
ARC 1950	Arc 1950 - Zimbabwe	CAPE	Cape Canaveral - Bahamas,
ZIMBABWE		CANAVERAL	Florida
		BAHAMAS FL	

CARTHAGE	Carthage - Tunisia	EUROPEAN	European 1950
TUNISIA		1950 ITALY	Italy (Sardinia)
		(SARDINIA)	
CH-1903	Switzerland	EUROPEAN	European 1950
CHATHAM	Chatham Island Astro 1971	1950 ITALY	(Sicily)
ISLAND ASTRO	New Zealand (Chatham Island)	(SICILY)	
NEW ZEALAND		EUROPEAN	European 1950
CHUA ASTRO	Chua Astro	1950	Malta
PARAGUAY	Paraguay	MALTA	
CORREGO	Corrego Alegre	EUROPEAN	European 1950
ALEGRE	Brazil	1950 SPAIN	Portugal, Spain
BRAZIL		PORTUGAL	
DABOLA	Dabola	EUROPEAN	European 1979
GUINEA	Guinea	1979	Mean for Austria, Finland,
		MEAN	Netherlands, Norway, Spain,
			Sweden, Switzerland
DJAKARTA	Djakarta (Batavia)	FORT THOMAS	Fort Thomas, 1955
(BATAVIA)	Indonesia (Sumatra)	1955 NEVIS	Nevis, St. Kitts
INDONESIA		ST. KITTS	(Leeward Islands)
DOS 1968	DOS 1968	GAN 1970	Gan 1970
NEW GEORGIA	New Georgia Islands	REPUBLIC OF	Republic of Maldives
ISLANDS	(Gizo Island)	MALDIVES	
EASTER	Easter Island 1967	GEODETIC	Geodeic Datum 1949
ISLAND	Easter Island	DATUM 1949	New Zealand
1967		NEW ZEALAND	
EUROPEAN	European 1950	GRACIOSA	Graciosa Base SW 1948
1950 MEAN	Mean for Austria, Belgium,	BASE SW	Azores (Faial, Graciosa, Pico,
WESTERN	Denmark, Finland, France,	1948 AZORES	Sao Jorge, Terceira)
	West Germany, Gibraltar, Greece,		
	Italy, Luxembourg, Netherlands,	GUAM	Guam 1963
	Norway, Portugal, Spain, Sweden,	1963	Guam
	Switzerland		
EUROPEAN	European 1950	GUNUNG	Gunung Segara
1950 MEAN	Mean for Austria, Denmark,	SEGARA	Indonesia (Kalimantan)
CENTRAL	France, West Germany,	INDONESIA	
	Netherlands, Switzerland		
EUROPEAN	European 1950	GUX 1 ASTRO	GUX 1 Astro
1950 MEAN	Mean for Iraq, Israel, Jordan,	GUADALCANAL	Guadalcanal Island
MIDDLE EAST	Lebanon, Kuwait,	ISLAND	
	Saudi Arabia, Syria	HERAT NORTH	Herat North
EUROPEAN	European 1950	AFGHANISTAN	Afghanistan
1950	Cyprus	HJORSEY	Hjorsey 1955
CYPRUS		1955	Iceland
EUROPEAN	European 1950	ICELAND	
1950	Egypt	HONG KONG	Hong Kong 1963
EGYPT		1963	Hong Kong
EUROPEAN	European 1950	HU-TZU-SHAN	Hu-Tzu-Shan
1950 GREAT	England, Channel Islands, Ireland,	TAIWAN	Taiwan
BRITAIN	Scotland, Shetland Islands	INDIAN	Indian
EUROPEAN '50	European 1950	BANGLADESH	Bangladesh
FINLAND	Finland, Norway	INDIAN	Indian
NORWAY		INDIA NEPAL	India, Nepal
EUROPEAN	European 1950	INDIAN 1954	Indian - 1954
1950	Greece	THAILAND	Thailand, Vietnam
GREECE		VIETNAM	
EUROPEAN	European 1950	INDIAN 1975	Indian - 1975
1950	Iran	THAILAND	Thailand
IRAN			

IRELANDIreland 1965
1965 Ireland

ISTS 061ISTS 061 Astro 1968
ASTRO 1968 South Georgia Islands
S GEORGIA

ISTS 073ISTS 073 Astro 1969
ASTRO 1969 Diego Garcia
DIEGO GARCIA

JOHNSTONJohnston Island 1961
ISLAND Johnston Island
1961

KANDAWALAKandawala
SRI LANKA Sri Lanka

KERGUELENKerguelen Island 1949
ISLAND Kerguelen Island
1949

KERTAU 1948Kertau 1948
W MALAYSIA West Malaysia & Singapore
SINGAPORE

KUSAIE ASTRO ...Kusaie Astro 1951
CAROLINE 1951 Caroline Islands
ISLANDS

L C 5 ASTROL.C. 5 Astro 1961
1961 CAYMAN Cayman Brac Island
BRAC ISLAND

LEIGONLeigon
GHANA Ghana

LIBERIALiberia 1964
1964 Liberia

LUZONLuzon
PHILIPPINES Philipines
(Excluding Mindanao)

LUZONLuzon
PHILIPPINES Philipines (Mindanao)
MINDANAO

MAHE ISLANDMahe 1971
1971 Mahe Island

MASSAWAMassawa
ETHIOPIA Ethiopia (Eritrea)
(ERITREA)

MERCHICHMerchich
MOROCCO Morocco

MIDWAY ASTRO ...Midway Astro 1961
1961 Midway Islands

MINNAMinna
CAMEROON Cameroon

MINNAMinna
NIGERIA Nigeria

MONTSERRATMontserrat Island Astro 1958
ISLAND Montserrat
ASTRO 1958 (Leeward Islands)

M'PORALOKOM'Poraloko
GABON Gabon

NAHRWANNahrwan
OMAN Oman (Masirah Island)

NAHRWANNahrwan
SAUDI ARABIA Saudi Arabia

NAHRWANNahrwan
UNITED ARAB United Arab Emirates
EMIRATES

NAPARIMA BWINaparima BWI
TRINIDAD AND Trinidad & Tobago
TOBAGO

N AMERICANorth American 1927
1927 MEAN Mean for Antigua, Barbados, Barbuda,
CARRIBEAN Caicos Islands, Cuba, Dominican
Republic, Grand Cayman, Jamaica,
Turks Islands

N AMERICANorth American 1927
1927 MEAN Mean for Belize, Costa Rica,
CENTRAL AMER El Salvador, Guatmla, Honduras,
Nicaragua

N AMERICANorth American 1927
1927 MEAN Mean for Canada
CANADA

N AMERICANorth American 1927
1927 MEAN Mean for CONUS
CONUS (Continental United States)

N AMERICANorth American 1927
1927 MEAN Mean for CONUS (East of Mississippi
CONUS EAST River) including Louisiana, Missouri,
Minnesota

N AMERICANorth American 1927
1927 MEAN Mean for CONUS
CONUS WEST (West of Mississippi River)

N AMERICANorth American 1927
1927 ALASKA Alaska

N AMERICANorth American 1927
1927 BAHAMAS Bahamas
(NO SAN SALV) (Except San Salvador Island)

N AMERICANorth American 1927
1927 BAHAMAS Bahamas (San Salvador Island)

N AMERICANNorth American 1927
1927 CANADA Canada (Alberta, British Columbia)
(WEST)

N AMERICANNorth American 1927
1927 CANADA Canada (Manitoba, Ontario)
(CENTRAL)

N AMERICANNorth American 1927
1927 CANADA Canada (New Brunswick,
EAST Newfoundland, Nova Scotia, Quebec)

N AMERICANNorth American 1927
1927 CANADA Canada (Northwest Territories,
NORTH Saskatchewan)

N AMERICANNorth American 1927
1927 CANADA Canada (Yukon)
YUKON

N AMERICAN North American 1927	PITCAIRN Pitcairn astro 1967
1927 CANAL Canal Zone	ASTRO Pitcairn Island
ZONE	1967
N AMERICAN North American 1927	POINT 58 Point 58
1927 CUBA Cuba	BURKINA Mean for Burkina Faso & Niger
N AMERICAN North American 1927	FASO NIGER
1927 Greenland (Hayes Peninsula)	POINTE NOIRE Pointe Noire 1948
GREENLAND	1948 CONGO Congo
N AMERICAN North American 1927	PORTO SANTO Porto Santo 1936
1927 MEXICO Mexico	1936 MADEIRA Porto Santo, Madeira Islands
	ISLANDS
N AMERICAN North American 1983	PROVISIONAL Provisional S. American 1956
1983 ALASKA Alaska, Canada, CONUS	S AMERICA Mean for Bolivia, Chile, Colombia,
CANADA CONUS	1956 MEAN Ecuador, Guyana, Peru, Venezuela
N AMERICAN North American 1983	PROVISIONAL Provisional S. American 1956
1983 CENTRAL Central America, Mexico	S AMERICA Bolivia
AM MEXICO	1956 BOLIVIA
OBSERVATORIA ... Observaorio Metereo 1939	PROVISIONAL Provisional S. American 1956
METEREO Azores (Corvo & Flores Islands)	S AMERICA Chile (Northern, Near 19°S)
1939 AZORES	1956 N CHILE
OLD EGYPTIAN Old Egyptian 1907	PROVISIONAL Provisional S. American 1956
1907 EGYPT Egypt	S AMERICA Chile (Southern, Near 43°S)
OLD HAWAIIAN Old Hawaiian	1956 S CHILE
MEAN Mean for Hawaii, Kauai,	PROV S AMER Provisional S. American 1956
Maui, Oahu	1956 Colombia
OLD HAWAIIAN Old Hawaiian	COLOMBIA
HAWAII Hawaii	PROVISIONAL Provisional S. American 1956
OLD HAWAIIAN Old Hawaiian	S AMERICA Ecuador
KAUAI Kauai	1956 ECUADOR
OLD HAWAIIAN Old Hawaiian	PROVISIONAL Provisional S. American 1956
MAUI Maui	S AMERICA Guyana
OLD HAWAIIAN Old Hawaiian	1956 GUYANA
OAHU Oahu	PROVISIONAL Provisional S. American 1956
OMAN Oman	S AMERICA Peru
Oman	1956 PERU
ORD SURVEY Ordinance Survey	PROVI S AMER Provisional S. American 1956
G BRITAIN Great Britain 1936 - Mean for	1956 Venezuela
1936 MEAN England, Isle of Man, Scotland,	VENEZUELA
Shetland Islands, Wales	PROVISIONAL Provisional S. American 1956
ORD SURVEY Ordinance Survey	S CHILEAN Chile (South, Near 53°S) (Hito XVIII)
G BRITAIN Great Britain 1936 - England	1963 S CHLIE
1936 ENGLAND	PUERTO RICO Puerto Rico
ORD SURVEY G ... Ordinance Survey	VIRGIN Puerto Rico, Virgin Islands
BRITAIN 1936 Great Britain 1936 - England,	ISLANDS
ENGLND WALES Isle of Man, Wales	QATAR Qatar National
ORD SURVEY G ... Ordinance Survey	NATIONAL Qatar
BRITAIN 1936 Great Britain 1936 - Scotland,	QORNOQ Qornoq
SCOTLAND Shetland Islands	GREENLAND Greenland (South)
ORD SURVEY Ordinance Survey	(SOUTH)
G BRITAIN Great Britain 1936 - Wales	REUNION Reunion
1936 WALES	MASCARENE Mascarene Islands
PICO DE Pico de las Nieves	ISLANDS
LAS NIEVES Canary Islands	ROME 1940 Rome 1940
CANARY ISLES	ITALY Italy (Sardinia)
	(SARDINIA)

RT 90Sweden

SANTO (DOS)Santo (DOS)
 '65 ESPIRITO 1965 Espirito Santo Island
 SANTO ISLAND

SAO BRAZSao Braz
 AZORES Azores (Sao Miguel,
 Santa Maria Islands)

SAPPER HILLSapper Hill 1943
 1943 EAST East Falkland Island
 FALKLAND ISLE

SCHWARZECKSchwarzeck
 NAMIBIA Nambia

SELVAGEM Selvagem Grande
 GRANDE Salvage Islands
 SALVAGE ISLE

SOVIETSGS 85
 GEODETIC Soviet Geodetic System 1985
 SYSTEM 1985

S AMERICANSouth American 1969
 1969 MEAN Mean for Argentina, Bolivia,
 Brazil, Chile, Colombia, Ecuador,
 Guyana, Paraguay, Peru,
 Trinidad & Tobago, Venezuela

S AMERICANSouth American 1969
 1969 ARGENTINA Argentina
 ARGENTINA

S AMERICANSouth American 1969
 1969 BOLIVIA Bolivia

S AMERICANSouth American 1969
 1969 BRAZIL Brazil

S AMERICANSouth American 1969
 1969 CHILE Chile

S AMERICANSouth American 1969
 1969 COLOMBIA Colombia

S AMERICANSouth American 1969
 1969 ECUADOR Ecuador
 ECUADOR

S AMERICANSouth American 1969
 1969 ECUADOR Ecuador (Baltra, Galapagos)
 GALAPAGOS

S AMERICANSouth American 1969
 1969 GUYANA Guyana

S AMERICANSouth American 1969
 1969 PARAGUAY Paraguay
 PARAGUAY

S AMERICANSouth American 1969
 1969 PERU Peru

S AMERICANSouth American 1969
 1969 TOBAGO Trinidad & Tobago
 AND TRINIDAD

S AMERICANSouth American 1969
 1969 VENEZUELA Venezuela
 VENEZUELA

SOUTH ASIASouth Asia

SINGAPORESingapore

TANANARIVETananarive Observatory 1925
 OBSERVATORY Madagascar
 1925
 MADAGASCAR

TIMBALAITimbalai 1948
 1948 BRUNEI Brunei, East Malaysia
 E MALAYSIA (Sabah, Sarawak)

TOKYOTokyo
 MEAN Mean for Japan, Korea, Okinawa

TOKYOTokyo
 JAPAN Japan

TOKYOTokyo
 KOREA Korea

TOKYOTokyo

OKINAWAOkinawa

TRISTAN DATristan Astro 1968
 CUNHA Tristan da Cunha
 ASTRO 1968

VITI LEVUViti Levu 1916
 1916 FIJI Fiji (Viti Levu Island)

WAKEWake

ENIWETOK '60Eniwetok 1960

MARSHALL ISLMarshall Islands

WAKE ISLANDWake Island Astro 1952
 ASTRO 1952 Wake Atoll

WGS 1972WGS 1972
 GLOBAL Global Definition
 DEFINITION

YACAREYacare
 URUGUAY Uruguay

ZANDERIJZanderij
 SURINAME Suriname

EAGLE ELECTRONICS FULL ONE-YEAR WARRANTY

"We", "our", or "us" refers to EAGLE ELECTRONICS, a division of LEI, the manufacturer of this product. "You" or "your" refers to the first person who purchases this product as a consumer item for personal, family, or household use.

We warrant this product against defects or malfunctions in materials and workmanship, and against failure to conform to this product's written specifications, all for one year (1) from the date of original purchase by you. WE MAKE NO OTHER EXPRESS WARRANTY OR REPRESENTATION OF ANY KIND WHATSOEVER CONCERNING THIS PRODUCT. Your remedies under this warranty will be available so long as you can show in a reasonable manner that any defect or malfunction in materials or workmanship, or any non-conformity with the product's written specifications, occurred within one year from the date of your original purchase, which must be substantiated by a dated sales receipt or sales slip. Any such defect, malfunction, or non-conformity which occurs within one year from your original purchase date will either be repaired without charge or be replaced with a new product identical or reasonably equivalent to this product, at our option, within a reasonable time after our receipt of the product. If such defect, malfunction, or non-conformity remains after a reasonable number of attempts to repair by us, you may elect to obtain without charge a replacement of the product or a refund for the product. THIS REPAIR, REPLACEMENT, OR REFUND (AS JUST DESCRIBED) IS THE EXCLUSIVE REMEDY AVAILABLE TO YOU AGAINST US FOR ANY DEFECT, MALFUNCTION, OR NON-CONFORMITY CONCERNING THE PRODUCT OR FOR ANY LOSS OR DAMAGE RESULTING FROM ANY OTHER CAUSE WHATSOEVER. WE WILL NOT UNDER ANY CIRCUMSTANCES BE LIABLE TO ANYONE FOR ANY SPECIAL, CONSEQUENTIAL, INCIDENTAL, OR OTHER INDIRECT DAMAGE OF ANY KIND.

Some states do not allow the exclusion or limitation of incidental or consequential damages, so the above limitations or exclusions may not apply to you.

This warranty does NOT apply in the following circumstances: (1) when the product has been serviced or repaired by anyone other than us, (2) when the product has been connected, installed, combined, altered, adjusted, or handled in a manner other than according to the instructions furnished with the product, (3) when any serial number has been effaced, altered, or removed, or (4) when any defect, problem, loss, or damage has resulted from any accident, misuse, negligence, or carelessness, or from any failure to provide reasonable and necessary maintenance in accordance with the instructions of the owner's manual for the product.

We reserve the right to make changes or improvements in our products from time to time without incurring the obligation to install such improvements or changes on equipment or items previously manufactured.

This warranty gives you specific legal rights and you may also have other rights which may vary from state to state.

REMINDER: You must retain the sales slip or sales receipt proving the date of your original purchase in case warranty service is ever required.

EAGLE ELECTRONICS
PO BOX 669 CATOOSA, OK 74015
(800) 324-1354

Eagle's UPS Return Service - U.S.A. Only

Eagle Electronics and United Parcel Service (UPS) are proud to offer all of our customers free shipping for all units sent to us for repair or service. If you have to send this unit to the factory, and you are in the continental United States, use the enclosed UPS shipping label for easy, free shipping to our factory customer service department. There are six easy steps:

1. Call Eagle at the toll-free number on the back of this manual for a Return Authorization (RA) number and instructions about what accessories to return. **Do not return a product to the factory without a Return Authorization (RA) Number!**
2. Pack your unit and any accessories in the original shipping container, if possible. **Be sure to include proof of purchase for warranty verification!**
3. Write a brief note detailing the problem you're having with the unit. Please include your name, address, and daytime telephone number.
4. Please include payment for non-warranty repairs. Check, money order, Visa, or MasterCard may be used.
5. Fill in your name, address, zip code, date, and RA number in the blanks provided on the UPS form included with your unit.
6. Attach the label to the shipping box, tear off the tab for your receipt and give the package to any UPS driver or take the package to any UPS Customer Center. You will not be charged for this shipment.

That's it! Your unit will be shipped to Eagle's customer service department at no charge to you. Units under warranty will be returned to you at no charge.

NOTE!

Eagle will pay UPS surface shipping charges both to and from the factory for this unit in the event it needs repair. Your unit is insured against loss or shipping damage when you use the enclosed UPS label.

This UPS shipping offer is good only in the continental United States (excludes Alaska and Hawaii).

**KEEP THIS LABEL!
YOU WILL NEED IT IF YOU EVER NEED TO RETURN YOUR UNIT TO
THE FACTORY FOR REPAIR.**

Accessory Ordering Information

To order accessories such as power cables, please contact:

1) Your local marine dealer. Most quality dealers that handle marine electronic equipment should be able to assist you with these items. Consult your local telephone directory for listings.

2) LEI Extras, Inc. P.O. Box 129 Catoosa, OK 74015-0129
or call
800-324-0045
(USA orders only.)

Eagle Electronics may find it necessary to change or end our shipping policies, regulations, and special offers at any time. We reserve the right to do so without notice.

PAGES

Press the PAGES key to view the pages menu, then using the up and down arrow keys to switch between nav, plot, and groups screens. Use the right or left arrow keys to switch between different screens on each page.

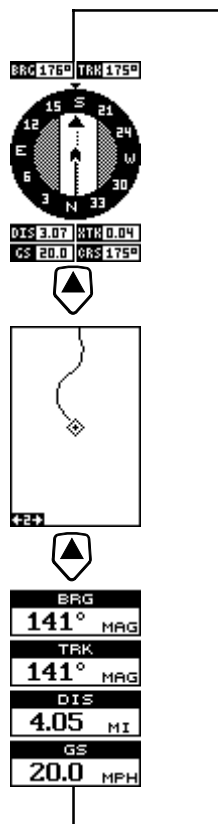
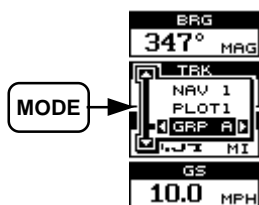

GROUPS SCREENS

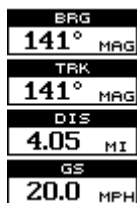

GRP A



GRP B



GRP C

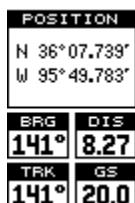

GRP H



GRP I

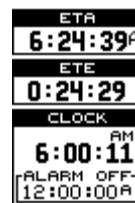

GRP J



GRP K

NAV SCREENS



NAV-1



NAV-2

PLOT SCREENS

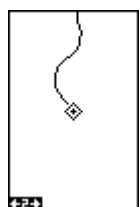

PLOT-1

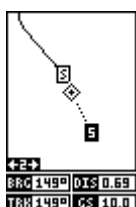

PLOT-2



GRP D



GRP E

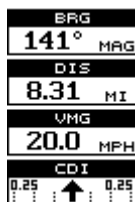

GRP F

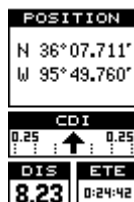

GRP G



GRP L

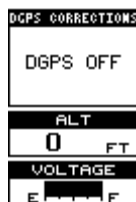

GRP M

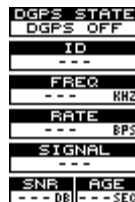

GRP N



GRP O

How to Obtain Service (Canadian Customers Only)

We back your investment in quality products with quick, expert service and genuine Eagle replacement parts. If you need service or repairs, contact the Eagle Factory Customer Service Department at the toll-free number listed below. A technician may be able to solve the problem and save you the inconvenience of returning your unit. You will be asked for your unit's serial number.

800-324-1354

Canada Only, Monday through Friday 8:00 A.M. - 8:00 P.M. Central Time.

When sending a product for repair, please do the following:

1. Always use the original shipping container and filler material the product was packed in when shipping your product.
2. Always insure the parcel against damage or loss during shipment. Eagle does not assume responsibility for goods lost or damaged in transit.
3. For proper testing, repair, and service, send a brief note with the product describing the problem. Be sure to include your name, return shipping address, and a daytime telephone number.

How to Obtain Service (International Customers Only - Except Canada)

If you need service or repairs, contact the dealer in the country you purchased your unit.

**WARRANTY REPAIR WILL BE HONORED ONLY IN THE
COUNTRY UNIT WAS PURCHASED.**

Please follow the shipping instructions shown below on this page if you have to mail your unit to the dealer. For proper testing, repair, and service, send a brief note with the product describing the problem. Be sure to include your name, return shipping address, and a daytime telephone number.

Accessory Ordering Information - All Countries

To order accessories such as power cables or transducers, please contact:

1. Your local dealer. Most quality dealers that handle GPS navigation equipment should be able to assist you with these items. Consult your local telephone directory for listings.
2. Canadian customers only can write:
Lowrance/Eagle Canada, 919 Matheson Blvd., E. Mississauga, Ontario L4W2R7
or fax 416-629-3118

How to Obtain Service - U.S.A. Only

We back your investment in quality products with quick, expert service and genuine Eagle™ replacement parts. If you're in the United States and you have questions, please contact the Factory Customer Service Department using our toll-free number listed below. You must send the unit to the factory for warranty service or repair. Please call the factory before sending the unit. You will be asked for your unit's serial number. Use the following toll-free number:

800-324-1354

U.S.A. only. Monday through Friday 8:00 A.M. - 8:00 P.M. Central time, except holidays.

Your unit is covered by a full one-year warranty. (See page 51 inside this manual for complete warranty details.) If your unit fails and the failure is not covered by the original warranty, Eagle has a flat-rate repair policy that covers your unit and accessories packed with the unit at the factory. There is a 180-day warranty on all non-warranty repairs from the factory, which is similar to the original warranty, but is for 180 days rather than one year. For further details, please call us at the above number.

Eagle also gives you free UPS shipping from anywhere in the continental United States both to and from the factory for all warranty repairs. You can also use the enclosed UPS shipping label for non-warranty shipments. See page 52 for more information. Remember, non-warranty repairs are subject to Eagle's published flat-rate charges and 180-day warranty.